



센서리움은 더 안전하고 쾌적한
미래를 위해 노력합니다.

Maximizes the comfort and safety world.

WHO WE ARE

센서리움은 전 세계의 Sales network를 통해 질 높은 고객 서비스와 기술 지원 서비스를 제공하며 항상 사용자의 의견에 귀 기울이고 있습니다.



Making sense for automatic applications

'주식회사 센서리움'은 '벨기에 HALMA Group의 계열사 BEA'의 한국 독점 에이전트입니다. 또한 혁신적인 센서 시스템을 개발, 구축하는 창의적인 기업입니다. 보행자용, 산업용 센서 외에도 4차 산업혁명에 부흥하는 다양한 솔루션을 제공하며, 사용자의 편의와 안전 향상을 위한 다양한 분야를 연구·개발하고 있습니다. 센서리움은 전 세계로 구축되어 있는 세일즈 네트워크를 통해, 질 높은 고객 서비스와 기술 지원 서비스를 제공하며 항상 사용자의 의견에 귀 기울이고 있습니다.

WHAT WE DO

- 입출입 감지
- 보안
- 교통 안전 솔루션
- 피플 카운팅
- 스마트 주차 시스템
- 스마트 도로 교통
- 스마트 인더스트리
- 스마트 시티
- 인터랙티브 미디어아트
- R&D



HOW WE SUPPORT

센서리움은 전 세계의 Sales network를 통해 질 높은 고객 서비스와 기술 지원 서비스를 제공하며 항상 사용자의 의견에 귀 기울이고 있습니다.

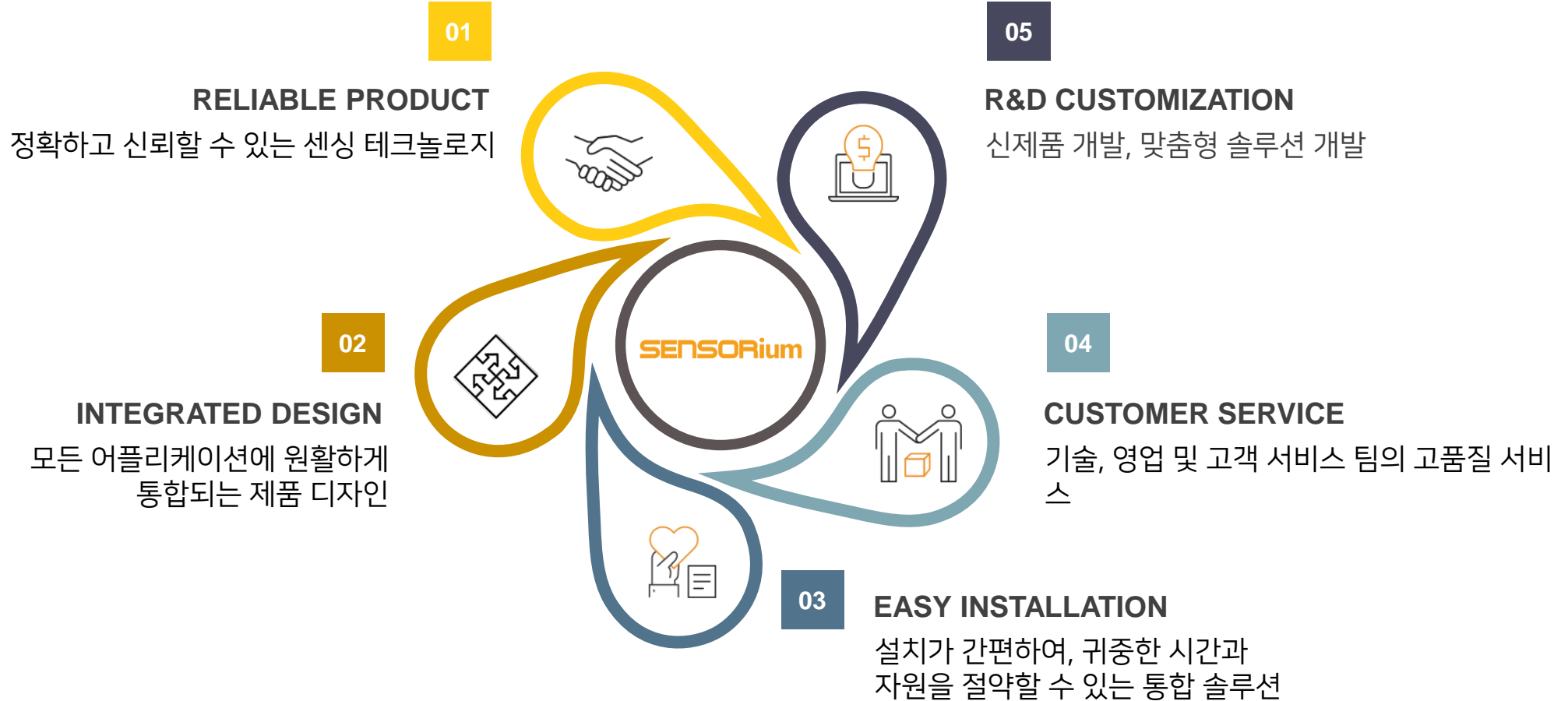

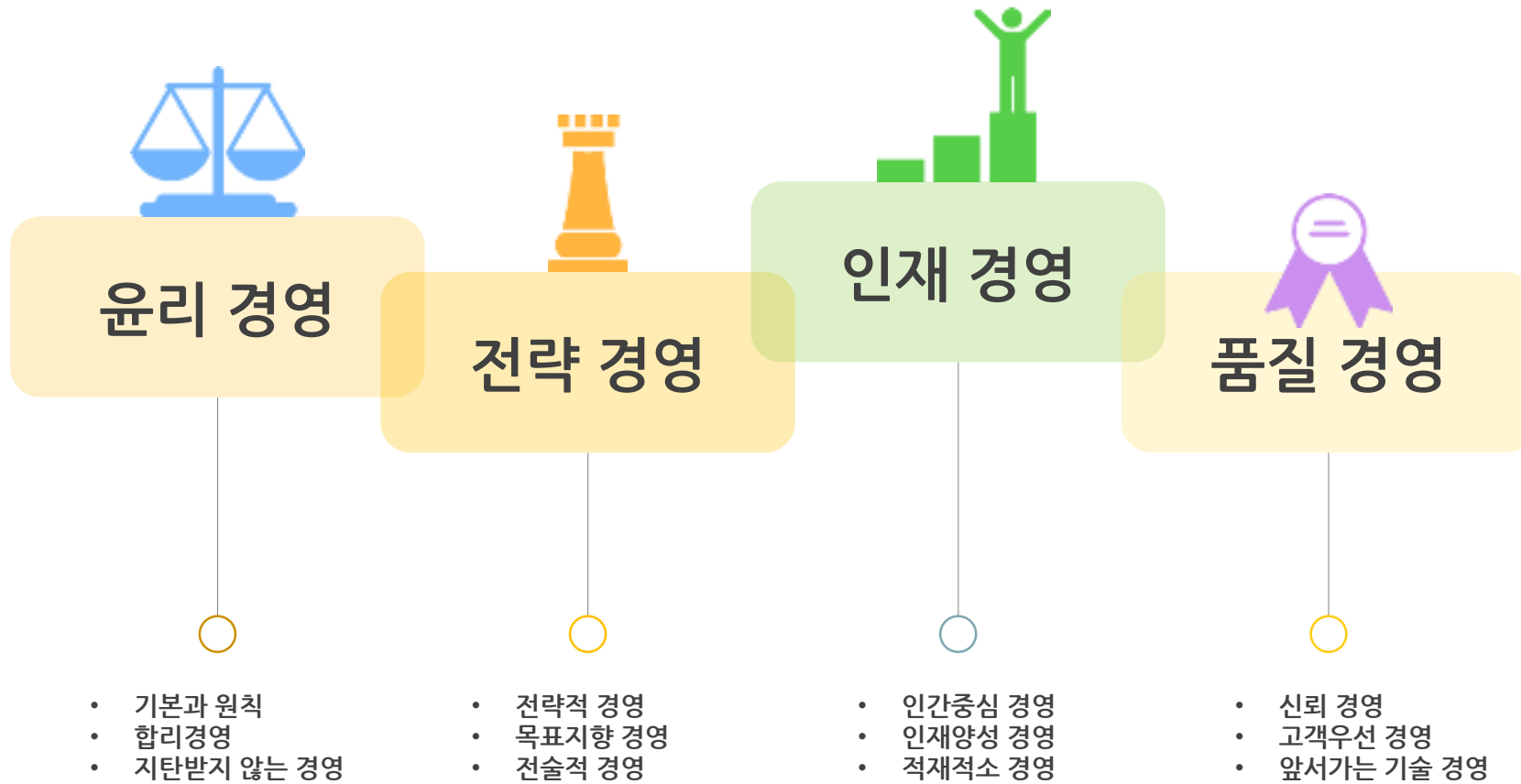



자유 · 책임

책임 있는 자유로운
회사문화를 지향합니다



신뢰 · 소통

신뢰하고 소통하며
최고의 성과를 창출합니다



열정 · 끊임

새로운 상상과 끊임없는
도전 정신을 지향합니다

인재상



전문성

전문적인 업무능력 보유



계획성

처음부터 끝까지 계획하고
실행하는 능력



추진력

과정과 결과 모두 만족할 수 있는
추진력과 리더십



도덕적

도덕적 가치관과 인간미



적극적

열정적, 적극적인 마음가짐

회사 연혁

2021

- 특허 등록 :
다차로차량 촬영 시스템
한 쌍의 레이저 스캐너가 구비된 인터랙티브 시스템에 의해 수행되는 터치영역을 기반으로 좌표정보를 생성하는 방법 및 이를 이용한 인터랙티브 시스템
- 물류 터미널용 스마트 물류 분리를 위한 체적 측정 시스템 개발

2020

- 2019년 창업성장기술개발 사업 완료
물류 터미널용 스마트 물류 분리를 위한 체적 측정 시스템 개발
- 특허 등록 : 차량 검지 장치 및 차량 검지 방법

2019

- 인터랙티브 가상 터치 시스템 개발
- 차량 높이 측정 및 알람 시스템 개발
- 피플카운팅 센서 및 모니터링 프로그램 개발
- 메인비즈 기업 인증
- SIGMA 연동 솔루션 개발
- 벤처 재 인증
- ISO 인증
- 경화여자 English Business 고등학교 협약체결
- 이노비즈 기업 인증
- 경기 가족 친화 일하기 좋은 기업
- 열차 판별 시스템 개발

2018

- 창업성장기술개발 사업 수행
- 물류 터미널용 스마트 물류 분리를 위한 체적 측정 시스템 개발
- 하남-IP 닥터 사업 수행
- 인터랙티브 가상 터치 시스템 개발
- 차량 높이 측정 및 알람 시스템 개발
- 피플카운팅 센서 및 모니터링 프로그램 개발

2017

- 레이저 스캐너와 레이더 융복합 차량 감지 센서 기술 개발
- 경차 판별 솔루션 개발
- 다차로 무정차 차량 감시 센서(VDS) 기술 개발
- 특허 등록 : 원자재 적정량 측정 방법

2016

- 2017 대한민국 골든브랜드 대상
- 한국, 벨기에 정부 협력 양해각서 체결
- (ENTREPRENEURSHIP AND INDUSTRY 4.0 KOREA MEETS BELGIUM)

2015

- 디자인 등록
- 시큐리티월드 기업인터뷰
- 다차로 무정차 차량 감시 센서(VDS) 기술 개발
- 창업성장기술개발 사업 수행
- - 레이저 스캐너를 이용한 공간정보 활용을 위한 개방형 플랫폼 기술 개발

2014

- 기업 부설연구소 설립 인증
- 고객이 신뢰하는 브랜드대상 수상
- 센서리움 법인 전환
- 특허 등록 : 부착형 자동 슬라이딩 도어 구동 장치
- 2015년 R&D 기획 지원사업 수행 수행
- - 3D 레이저 스캐너 센서를 이용한 지능형 물체 추적 시스템 개발
- 사내 연구소 설립

2013

- 단국대학교 산학 협력 협약
- 벤처기업 인증
- (사)중소기업융합경기연합회 정회원
- 벤처기업협회 정회원 등록
- 중소기업청 R&D 과제 수행 : 창업성장기술개발사업
- 중소기업청 IP R&D 과제 수행 : 국제 지재산분쟁 예방컨설팅
- 김생민의 비즈정보쇼 출연
- 경기도 우수 상품 전시관 입점
- 창업성장기술개발 사업 수행 - 부착형 슬라이딩 자동문 전환 시스템 개발

2012

- 연구전담부서 설립
- ISO 9001 인증_자동문 변환장치의 설계/개발 및 제조
- 경화여자 English Business 고등학교 공동 협약

2011

- 센서리움 설립

인증 현황

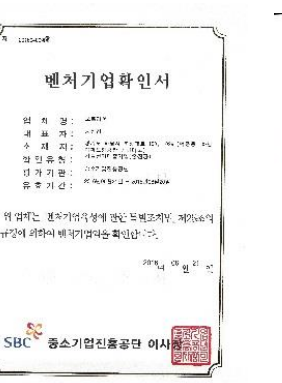
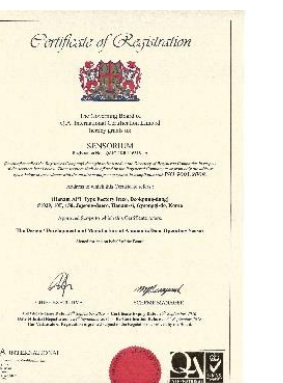
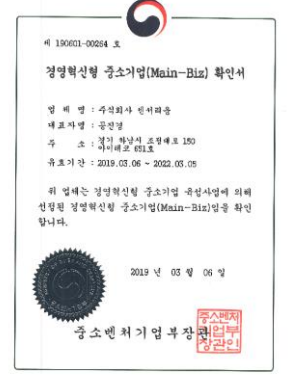
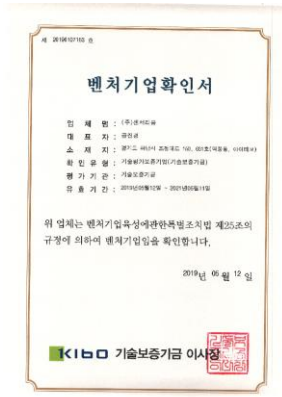
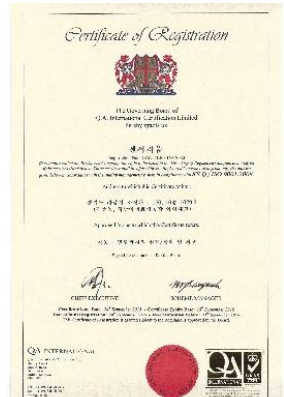

복지제도



4대보험



교육비지원



경조사지원



장기근속포상



생일축하선물



칭찬합시다 포상



콘도 · 리조트 이용권



문화의날



도서비지원



사내동호회지원



중 · 석식제공



사내 바 & 카페테리아



연 2회 워크샵
(1회 해외 워크샵 포함)



쇼핑 데이



연봉 외 매출에
따른 성과급



휴게시설
(수면실, 카페테리아, 안마의자)



문화 및 체육시설
(스크린골프, 노래방, 게임, 다트, 클럽하우스)



Technology & Products

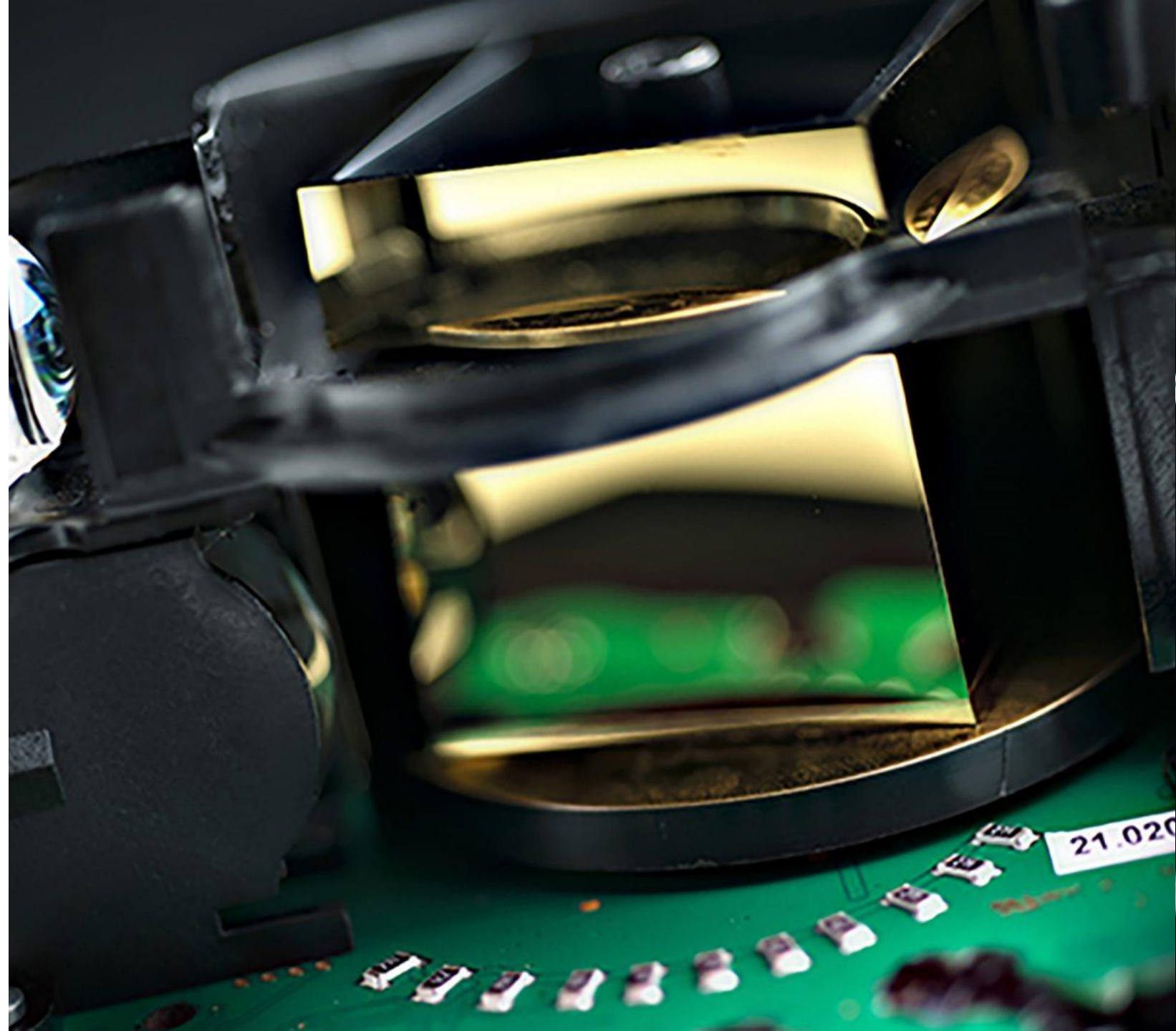

Technology & Products

Radar technology (Microwave)



Radar sensor



FALCON

산업용 도어, 오버헤드 도어에 사용되는 레이더 센서. 사람과 차량을 구분할 수 있음.



EAGLE

단방향, 양방향 선택이 가능한 자동 문용 센서.



MICROHEAD8

초소형 센서로, 자동문, 에스컬레이터 등 다양한 곳에 사용 가능.



ZEN



ECW8

자동문에 가장 보편적으로 사용되며, 가성비 좋은 센서.

Technology & Products

IR technology (Infrared ray)

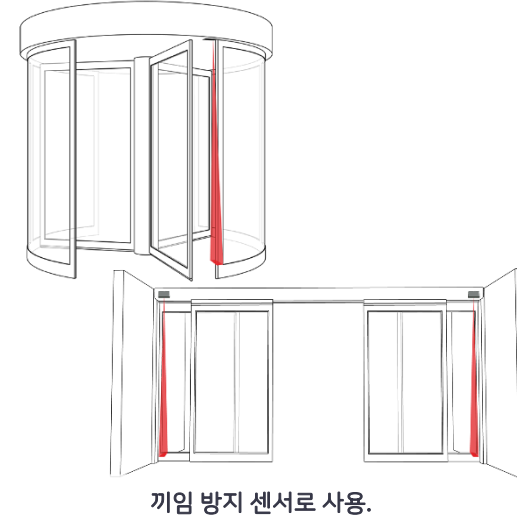
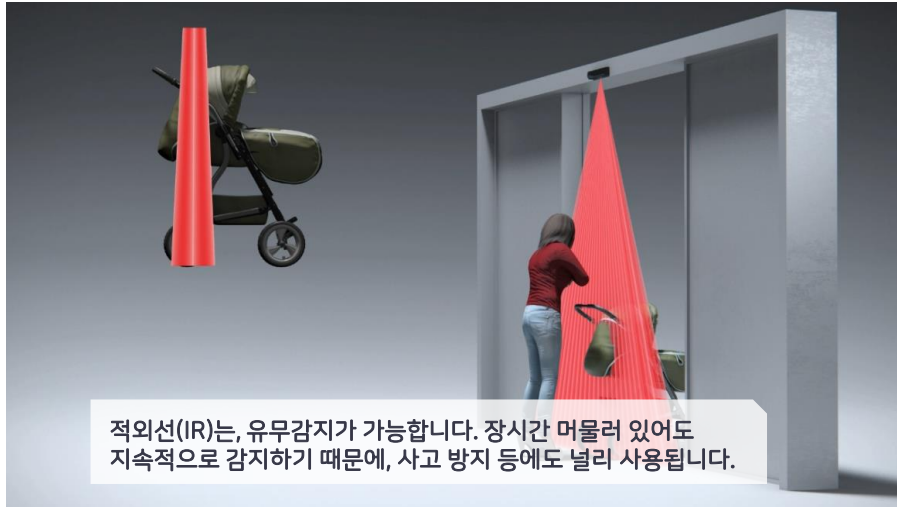

IR sensor



MILAN

Active 적외선 센서. 사람과 차량을 구분할 수 있으며 유무감지가 가능함.



MICROCELL

포토빔 센서. 종류에 따라 1빔, 2빔 등 선택이 가능함.



FLY UP

자동문용 적외선 센서. 매립이 가능하며 브라켓을 사용하여 외부 설치도 가능함.



SMART FOCUS

좁은 빔도 가능한 적외선 센서로, 끼임 방지로도 사용 가능함. 모든 종류의 자동문, 특히 회전문에 적합.



4SAFE



EYETECH

회전문과 스윙자동문에 쓰이는 센서. 길이별로 선택이 가능함.

Technology & Products

Dual technology (Radar + IR)



레이더와 적외선을 한 센서에 접목하여, 좀 더 다양한 기능 구현 가능. 유무감지 및 오프닝을 위해 두 기술을 합쳤습니다.



오프닝뿐만 아니라 세이프티 기능이 추가되었기 때문에, 자동문에 사용 시 프리미엄 급 센서로 구분됩니다. 유무감지 기능으로 사람을 무제한 감지하며 끼임 사고 방지에 알맞습니다.

Dual sensor



CONDOR

사람과 차량을 구분할 수 있는 산업용 센서. 교차 통행을 인지하며 설치 쉽고 빠름.



ZENSAFE

오프닝과 세이프티가 합쳐진 프리미엄급 자동문 센서



IXIO

LCD창이 탑재된 프리미엄급 센서 눈으로 확인 가능한 LED빛으로 감지영역을 조정함



VIO

오프닝과 세이프티가 합쳐진 프리미엄급 자동문 센서

Technology & Products

Laser technology

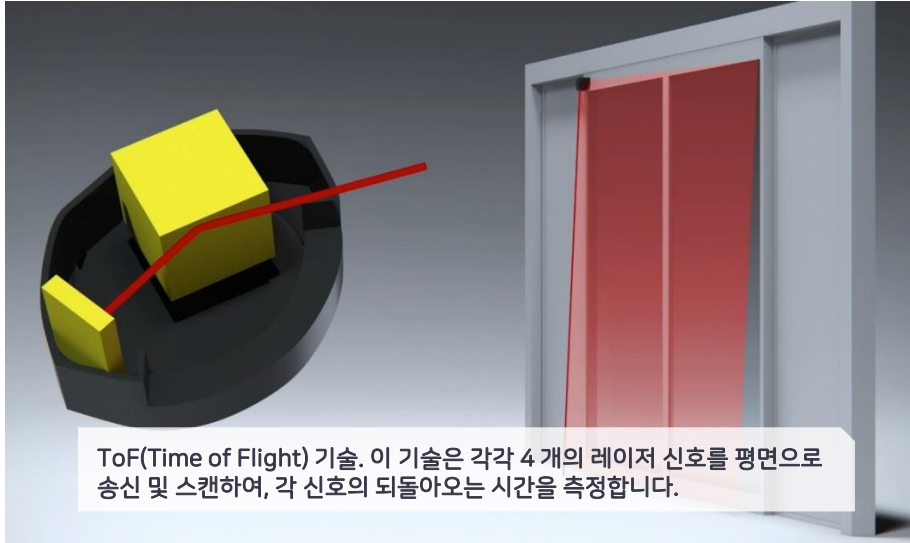

Laser scanner



LZR

가장 보편적으로 사용하는 센서리움의 레이저스캐너



MICROSCAN

스윙도어 등 자동문의 오프닝과 세이프티용 스캐너.



FLATSCAN

기존의 레이저스캐너보다 작은 크기



WIDESCAN

산업용 도어, 오버헤드 도어에 사용할 수 있는 프리미엄 레이저 스캐너



LSR-2001



RSR-4001

ITS, 각종 차량 정보 수집, 시뮬레이션이 가능.

Applications & Products



■ 사업 현황

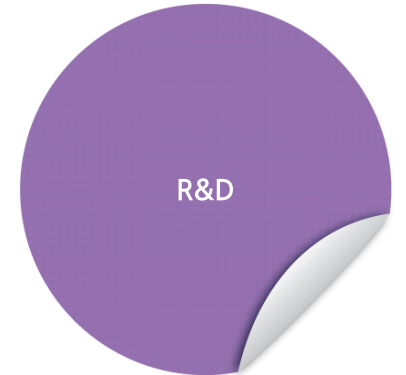
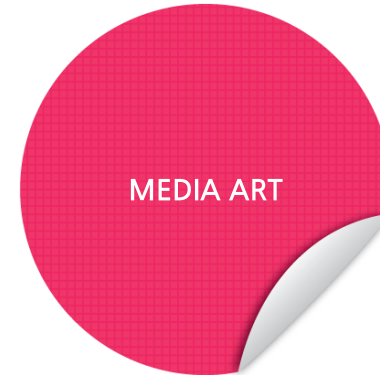
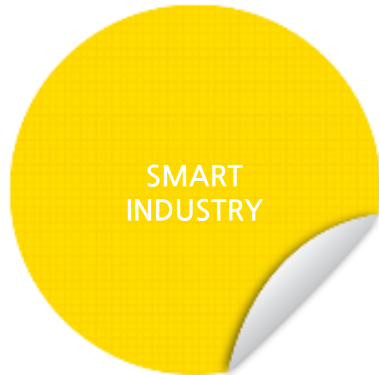

입출입통제

보행자 감지



버추얼 터치

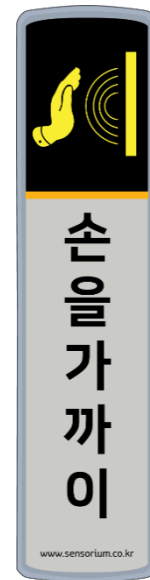

IN / OUT CONTROL

입출입통제

산업용 감지

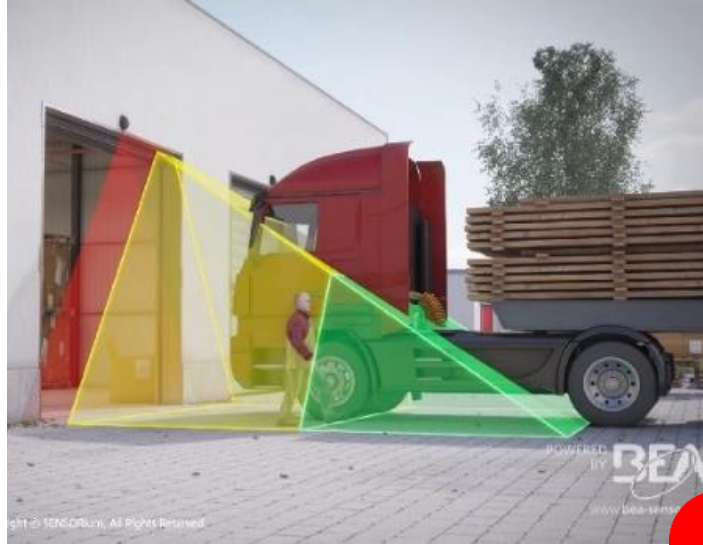

'LZR WIDESCAN'
을 검색하세요



IN /OUT
CONTROL

보안

미술관 및 실내 보안

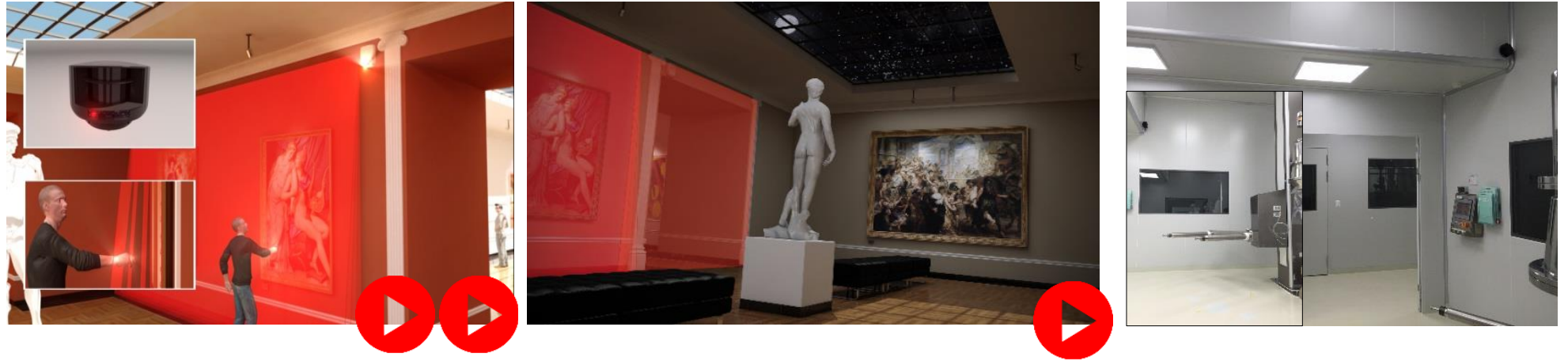

건물 및 외벽 보안

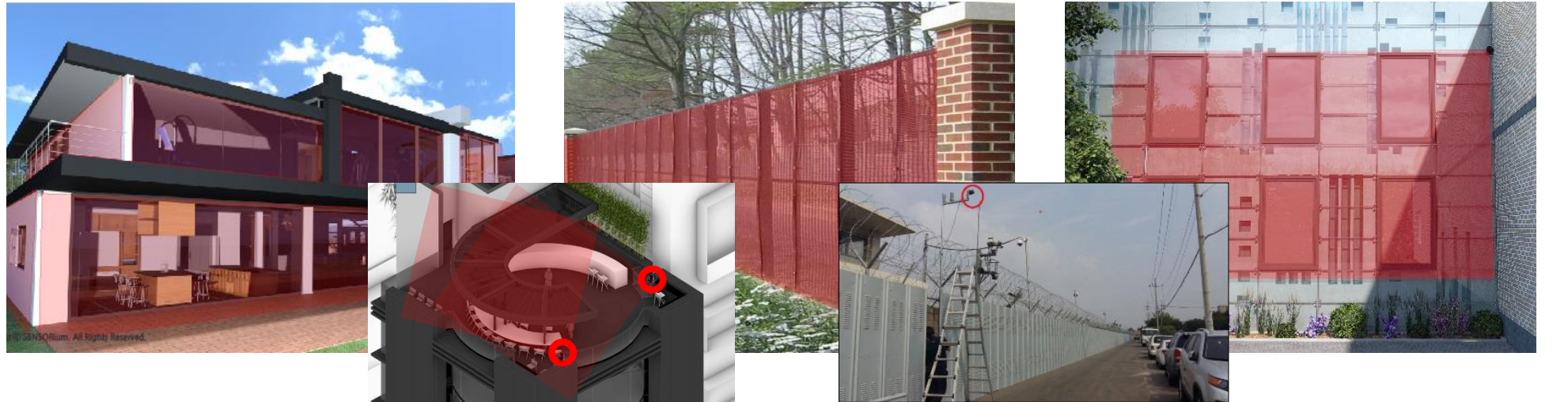

교통안전솔루션
PSD & RPSD



▶ VPSD



교통안전솔루션
열차 안전, 감지



교통안전솔루션

열차 추돌사고 방지

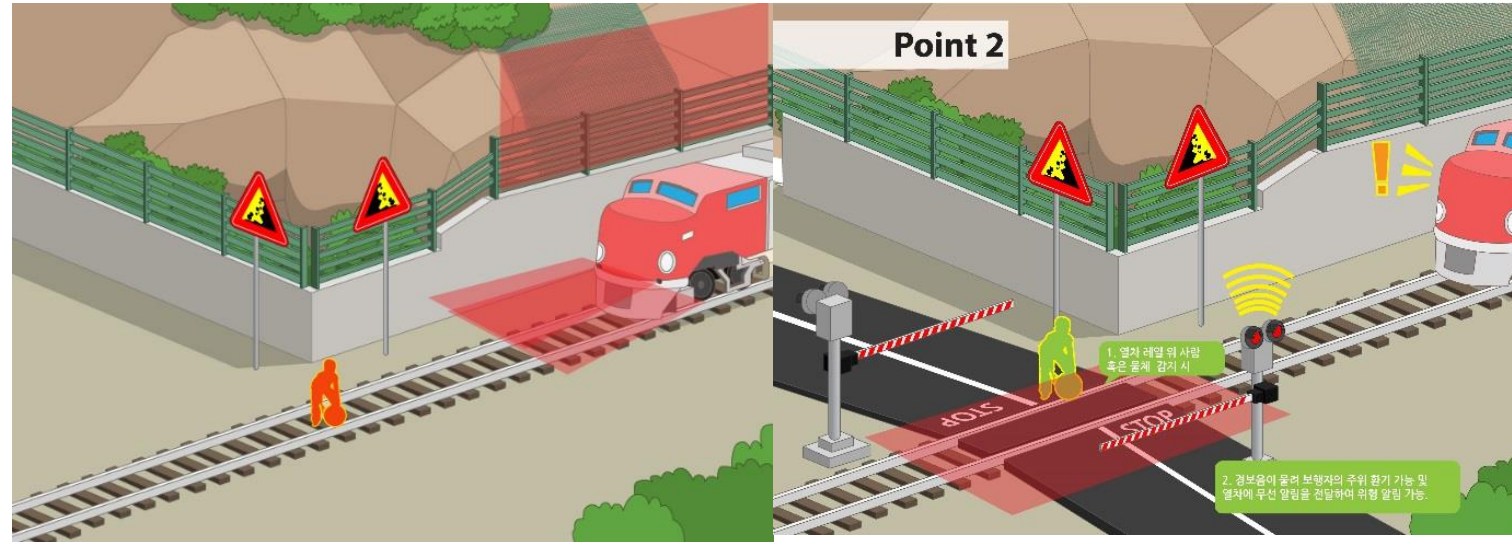

낙석 위험 알림

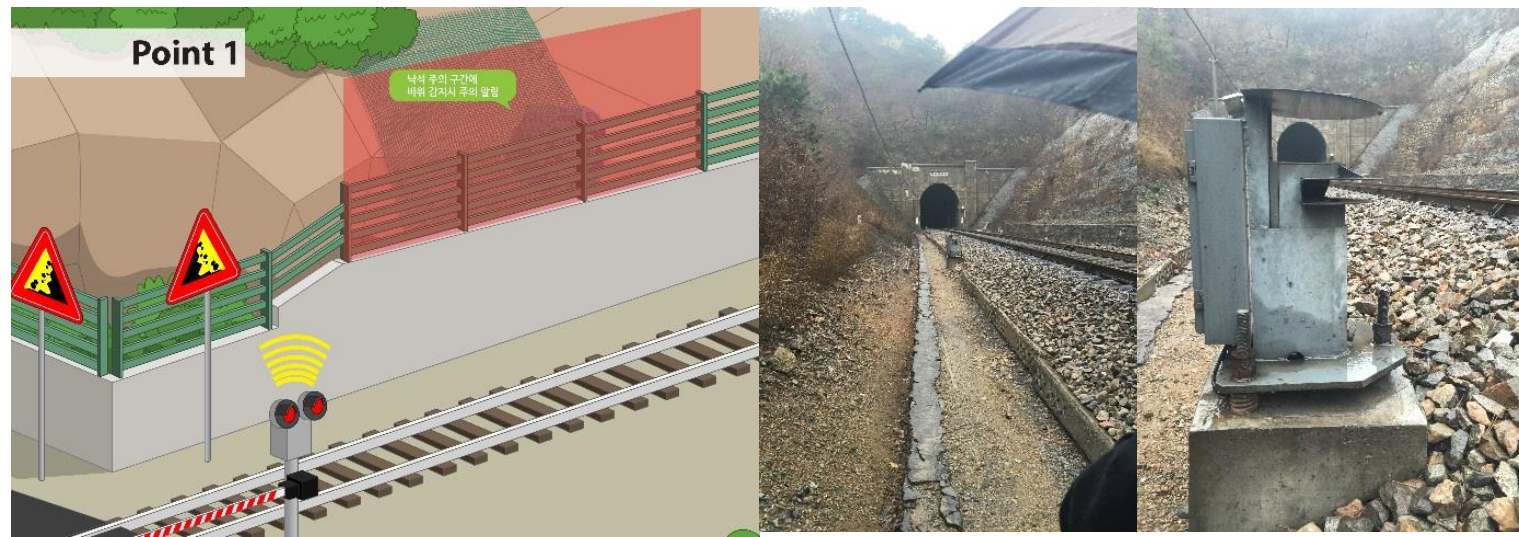

TRAFFIC
SAFETY
SOLUTION

교통안전솔루션
열차 진입 감지



■ 교통안전솔루션

철길 높이 감지, 진입 제한솔루션

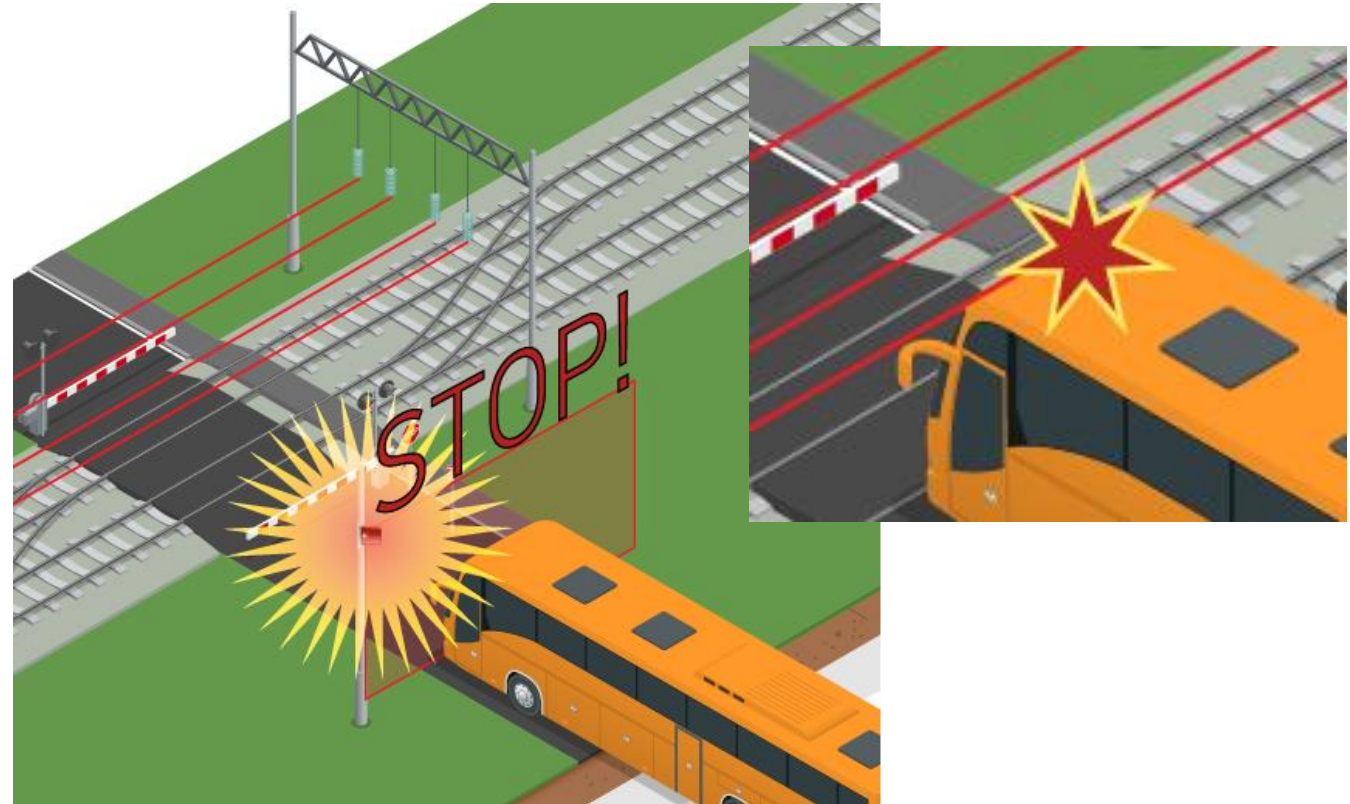
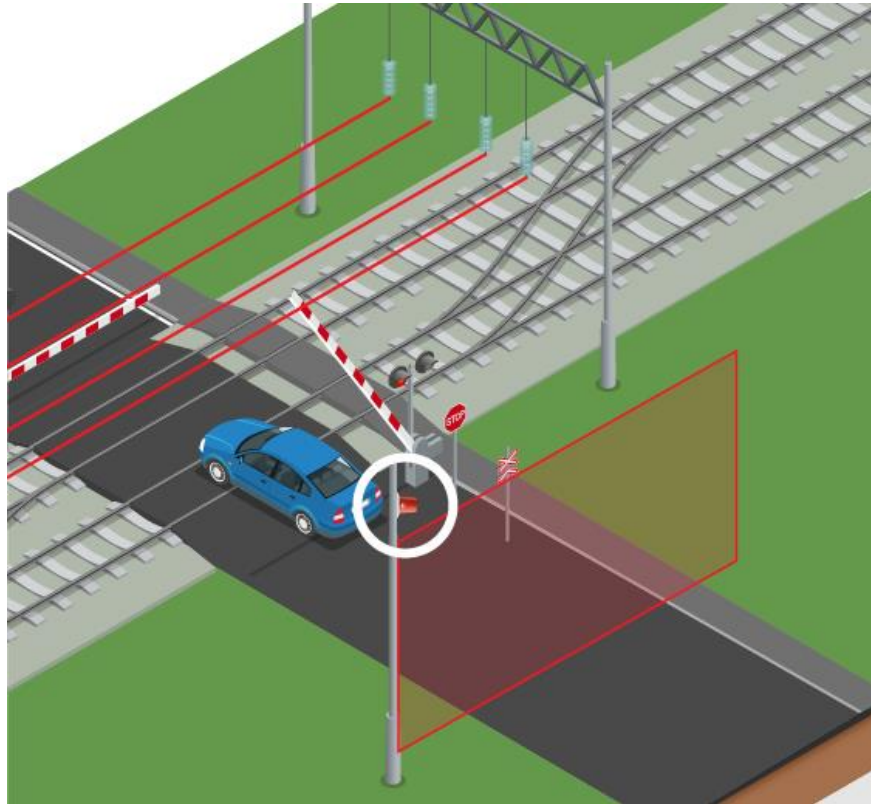

교통안전솔루션

도시 내 차량 감지, 속도감지 및 카운팅

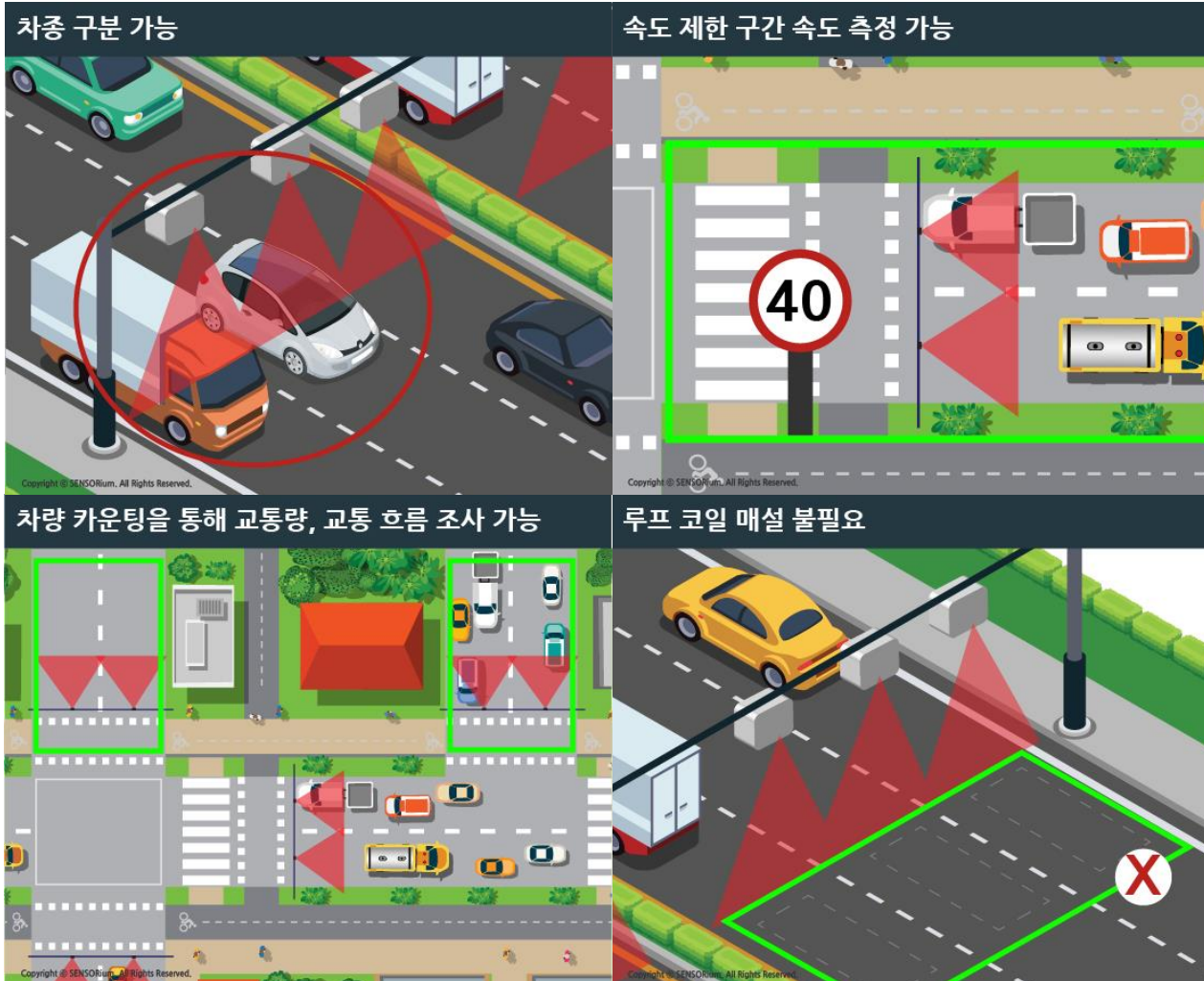

TRAFFIC
SAFETY
SOLUTION

피플카운팅

일반 피플카운팅 시스템



피플카운팅

위험시 잔존인원 확인



■ 피플카운팅
유동인구 분석

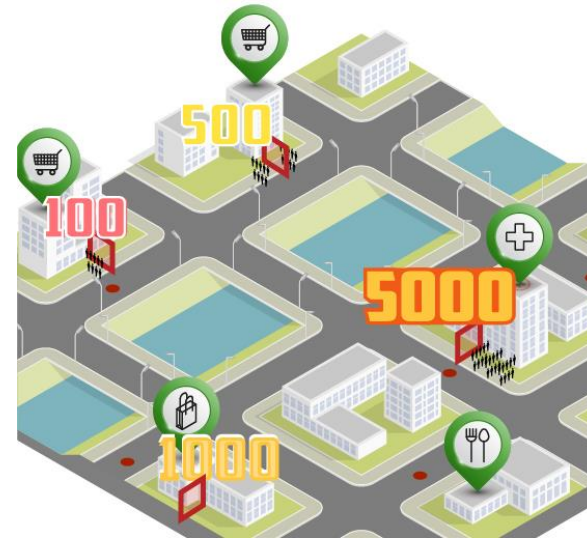

유동인구 수의 **정확한 데이터**는
신뢰성 높은 자료로 활용되어
부동산 가치를 높이는데
도움이 됩니다.



PEOPLE
COUNTING

피플카운팅

잔존인원, 대기열 관리



PEOPLE
COUNTING

■ 피플카운팅
대기열 혼잡도

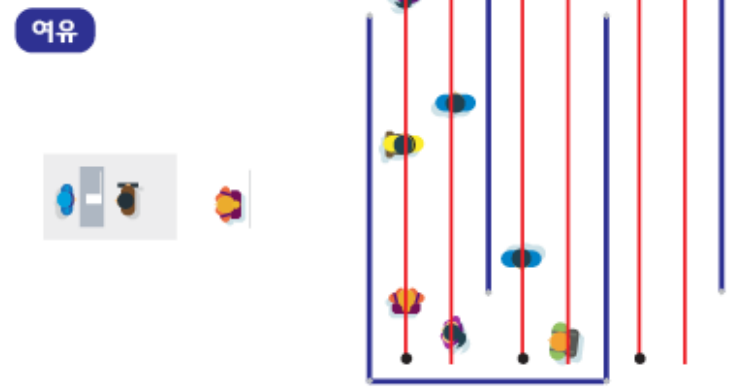
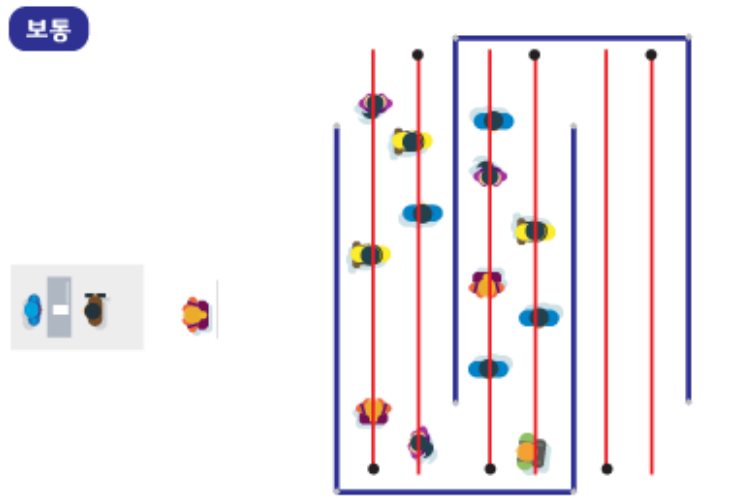
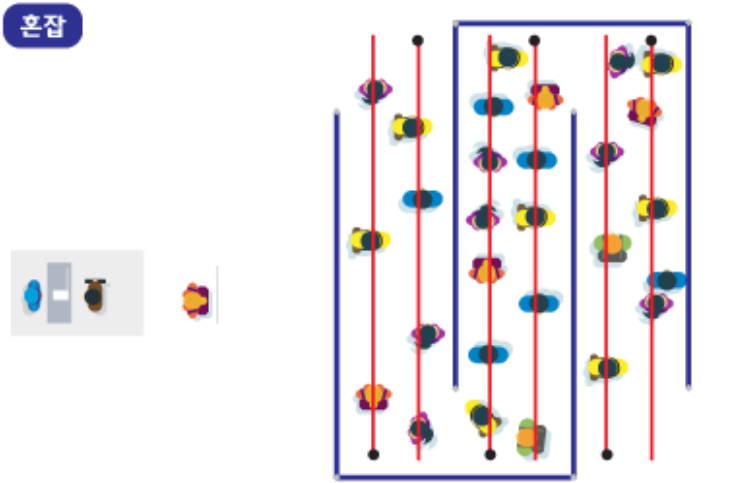

스마트 주차시스템
주차차단, 관제

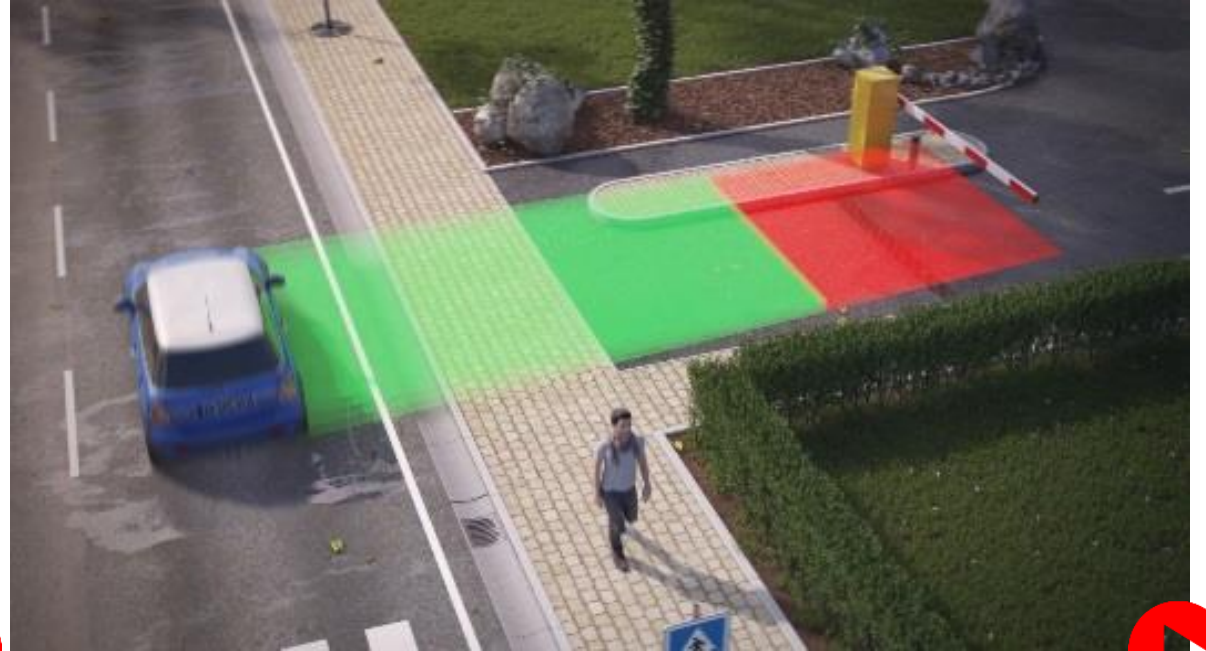

스마트 주차시스템
주차차단, 관제

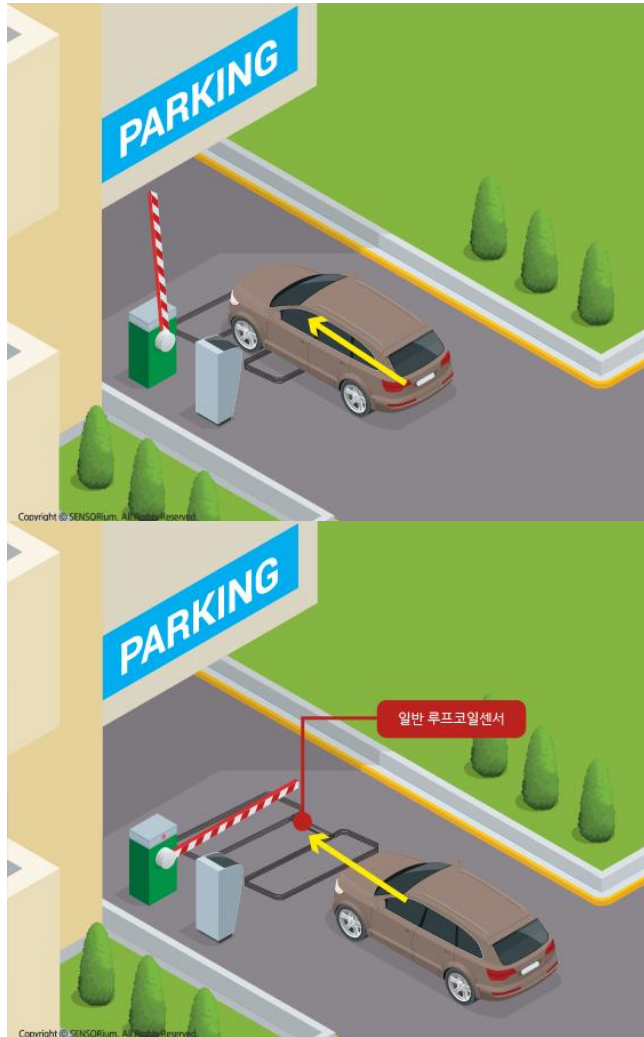

스마트 주차시스템

주차유도, 차량 카운팅

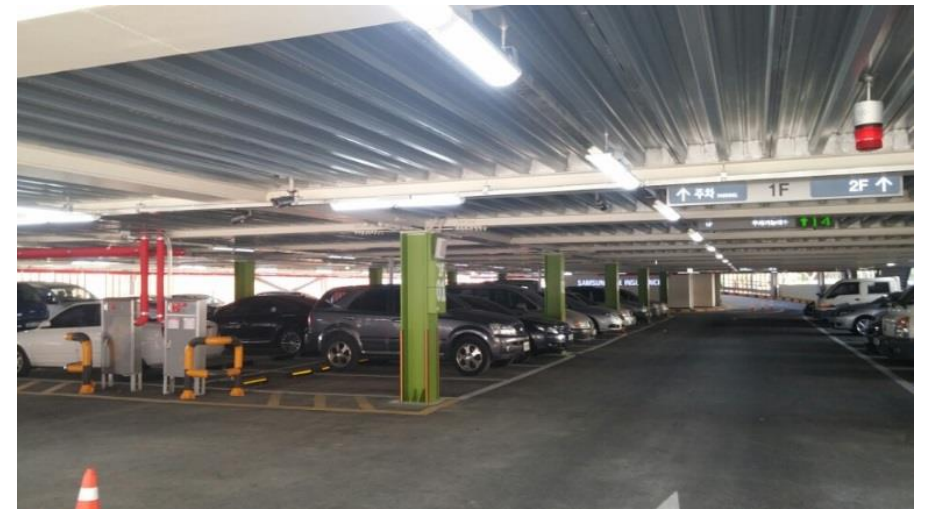
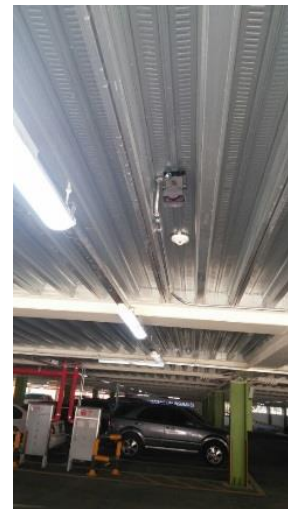
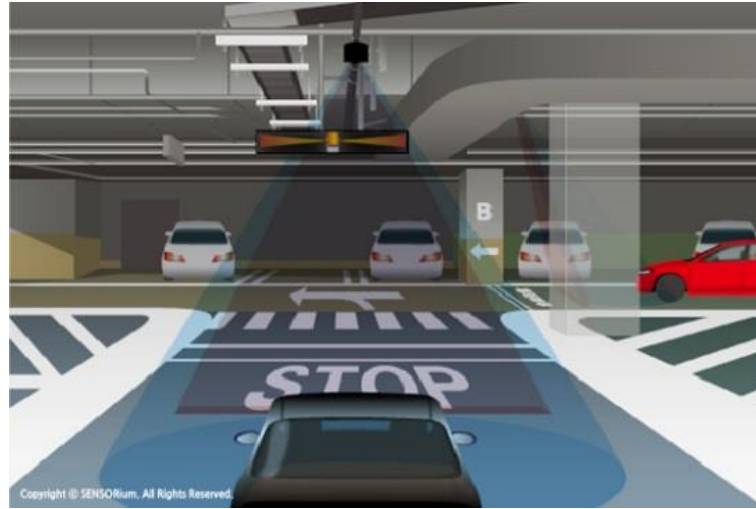

스마트 주차시스템
주차유도, 차량 카운팅

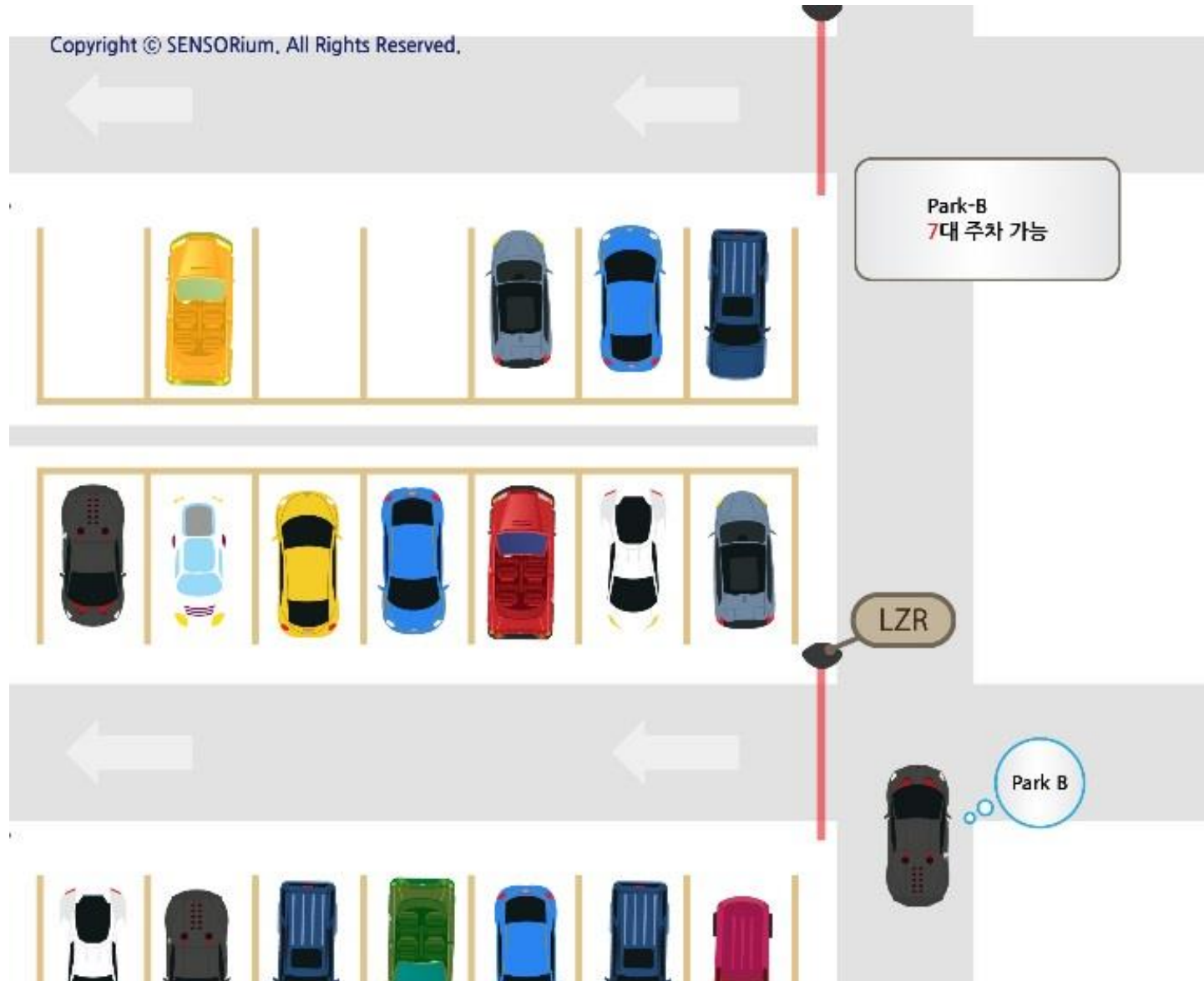

스마트 주차시스템

교차로 충돌 방지



지하주차장 교차로 충돌 사고

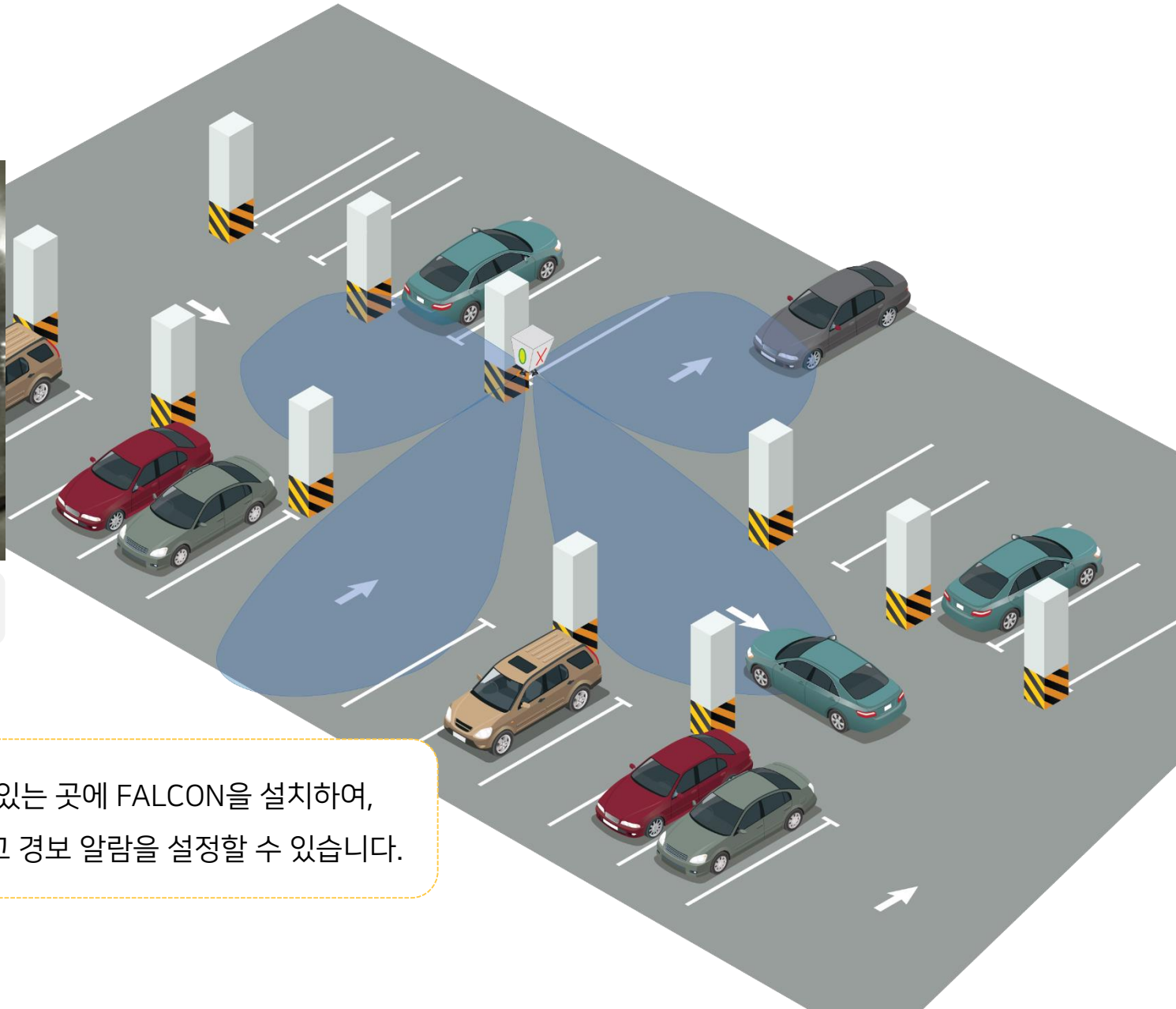

충돌 위험이 있는 곳에 FALCON을 설치하여,
차량을 감지하고 경보 알람을 설정할 수 있습니다.

SMART
PARKING
SYSTEM

스마트 주차시스템
자동주차시스템



스마트 주차시스템
차종구분시스템

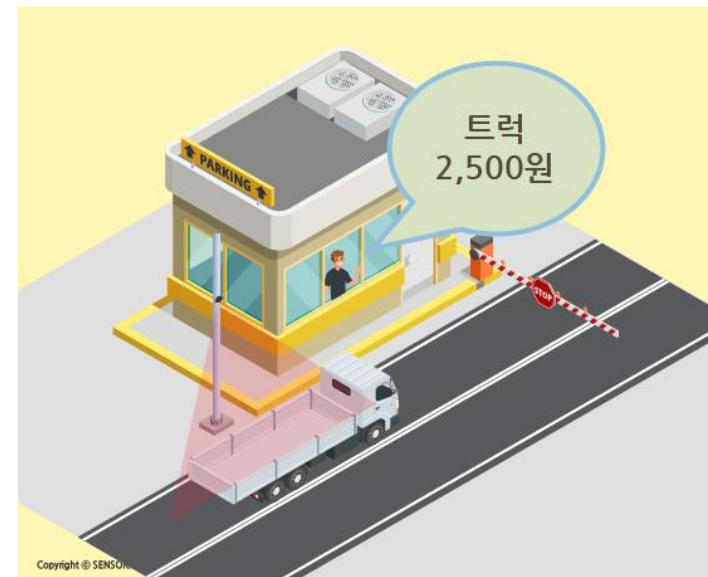
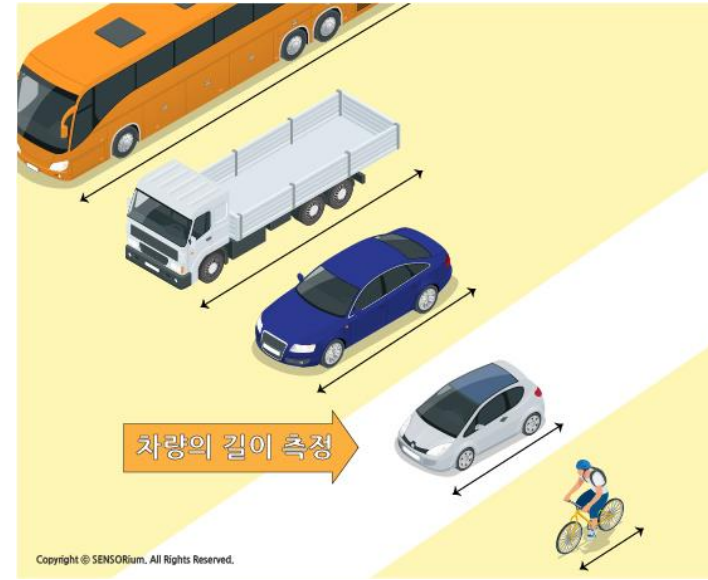

스마트 주차시스템
꼬리물기 (테일게이팅)



FOCUS2 장착!!
앞 차량 통과 완료 시
종료 신호를 보냅니다.
(차단기 원위치)

앞 차량 통과 완료 시
종료 신호를 보냅니다.
(차단기 원위치)



스마트 주차시스템
주차장 높이 제한 알림



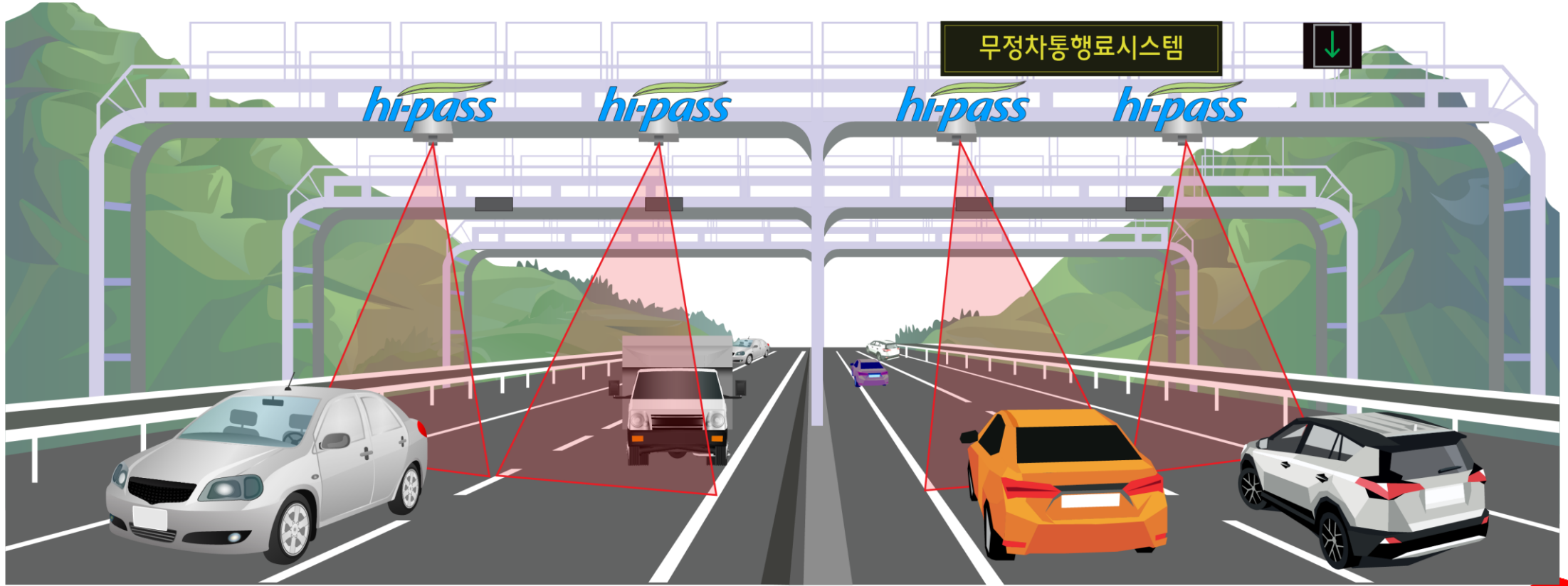

1. Top view

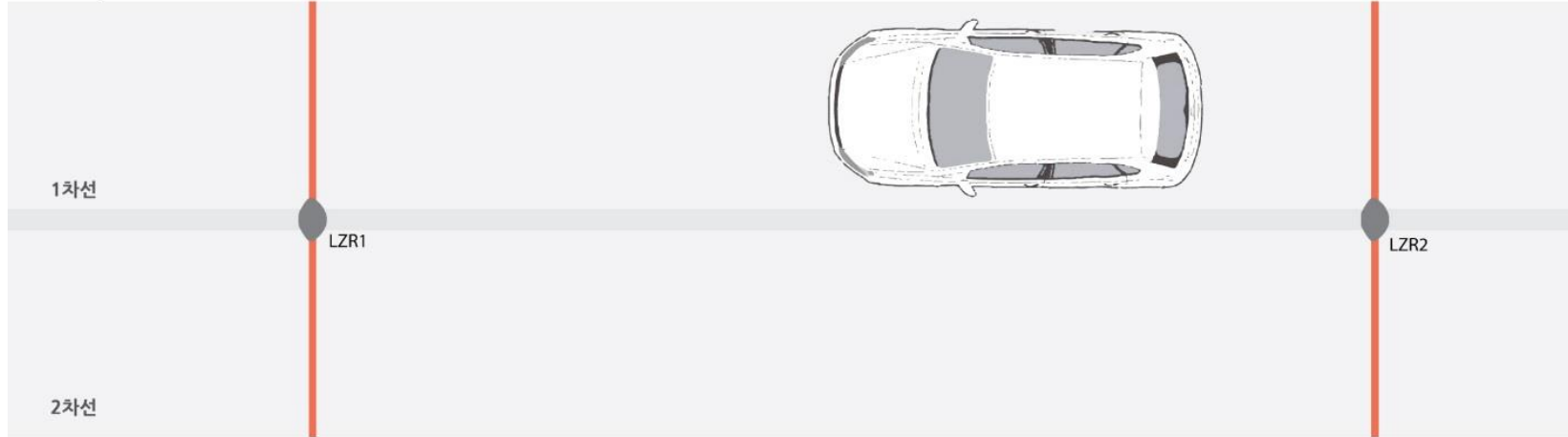

2. Side view



3. Front view

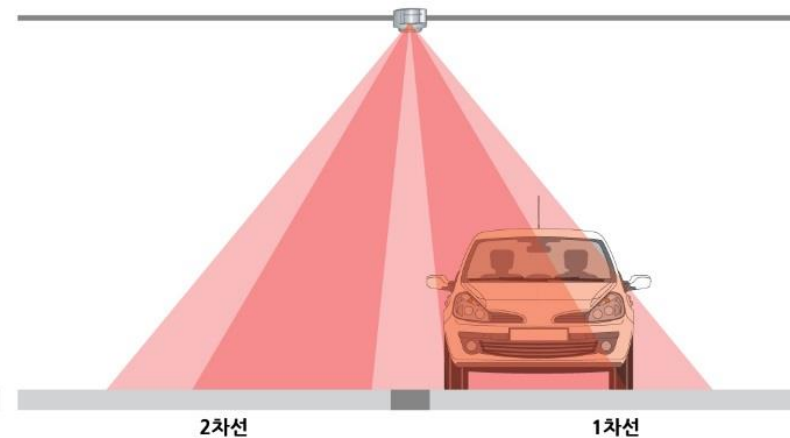

차량 카운팅	Aug.06 : 642
차종 구분	
속도 측정 길이, 높이 측정 과적, 체적 측정	81.5 km/h x : 5474 mm y : 1956 mm

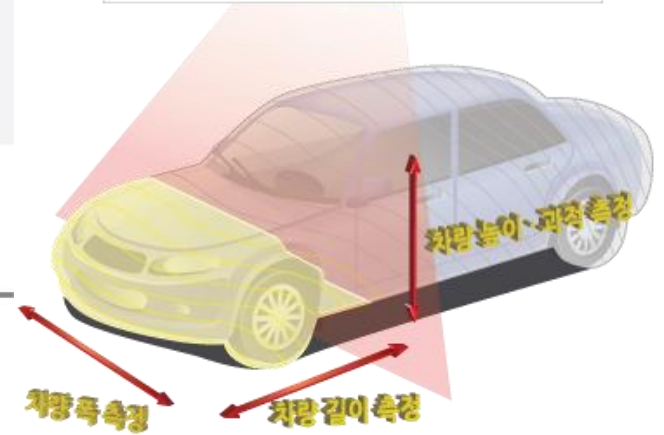

스마트 인터스트리

위험 관리, 예방

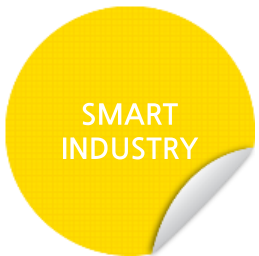

스마트 인터스트리
방폭센서

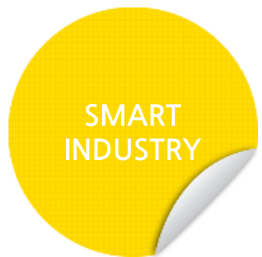
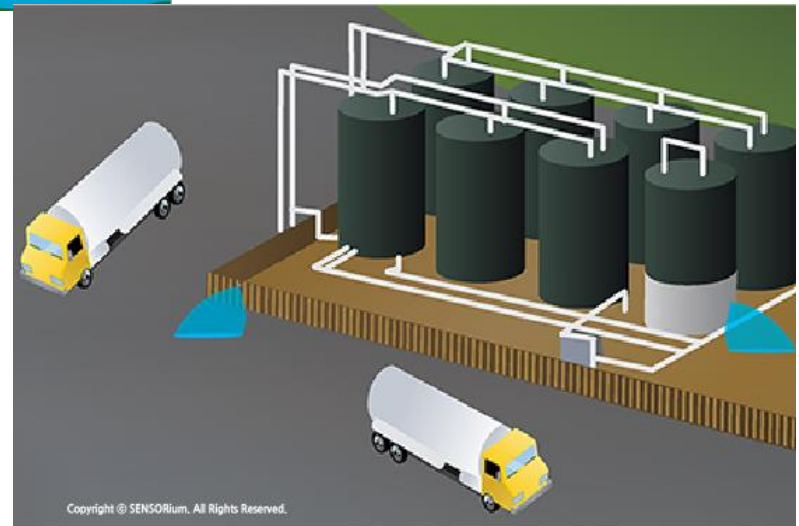
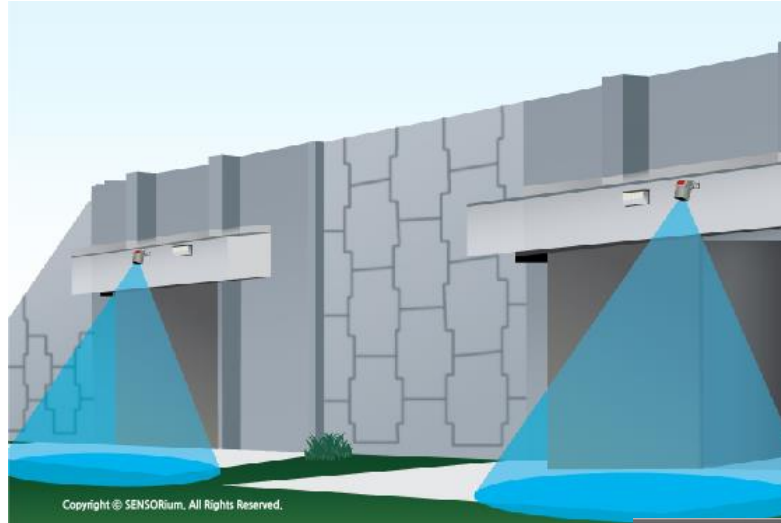
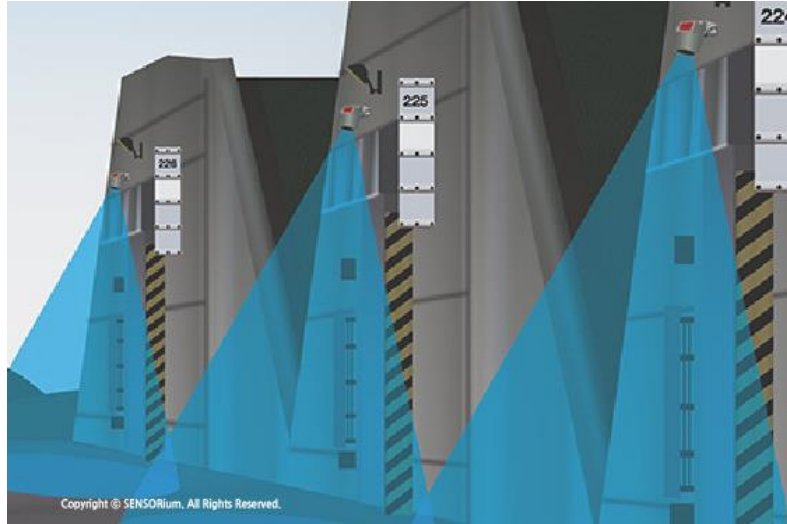

스마트 인더스트리

AGV



- 안전 영역
정해진 영역(Safety Field) 이내에 들어오면 충돌방지를 위한 감속·정지 동작을 해주어야 합니다.

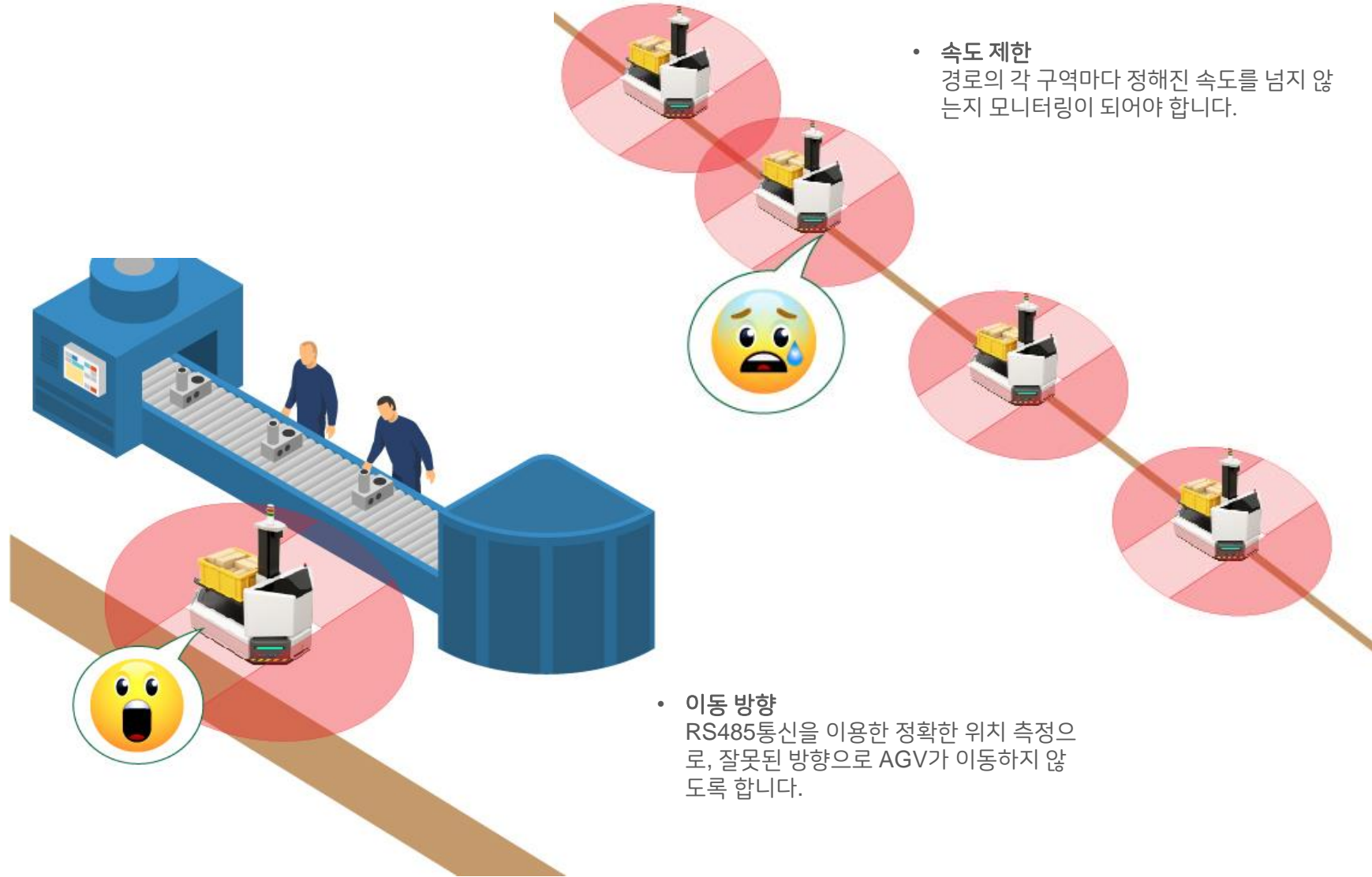

- 속도 제한
경로의 각 구역마다 정해진 속도를 넘지 않는지 모니터링이 되어야 합니다.

- 이동 방향
RS485통신을 이용한 정확한 위치 측정으로, 잘못된 방향으로 AGV가 이동하지 않도록 합니다.

스마트 인터스트리

컨테이너 적재, 부피 및 길이 측정

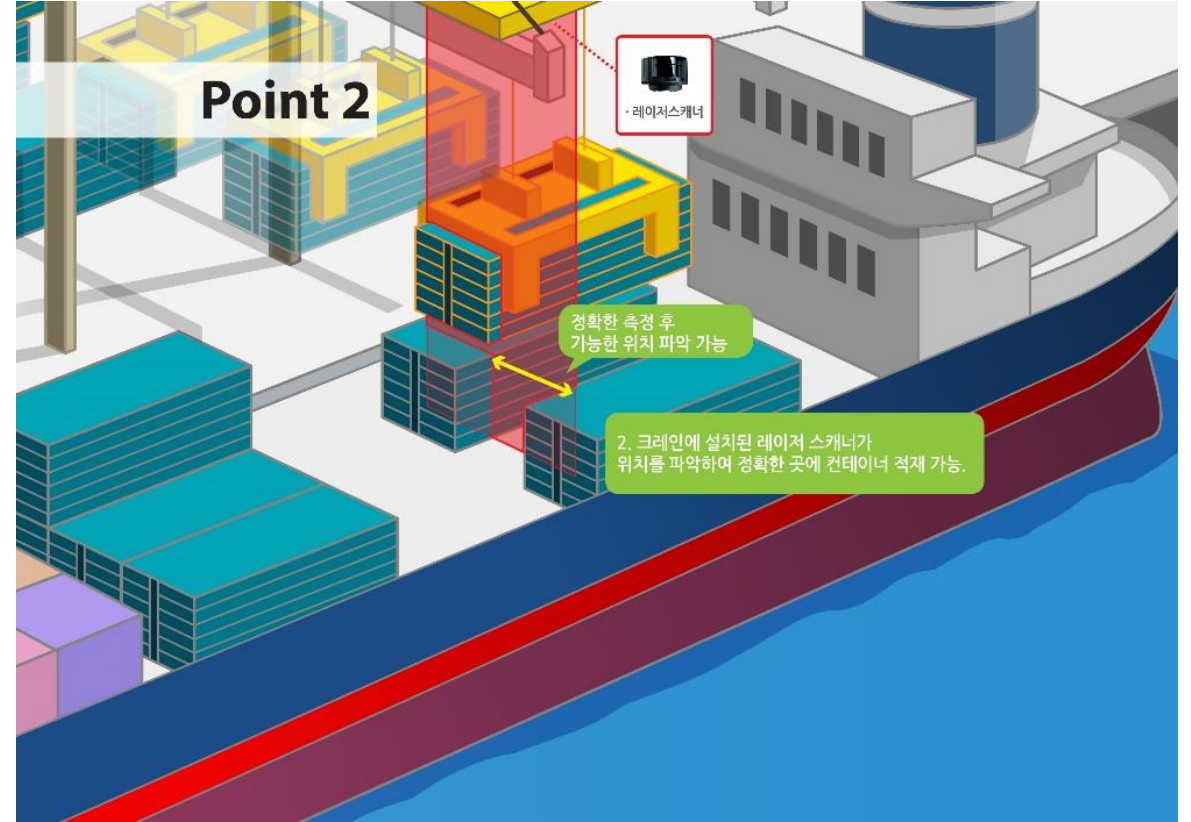
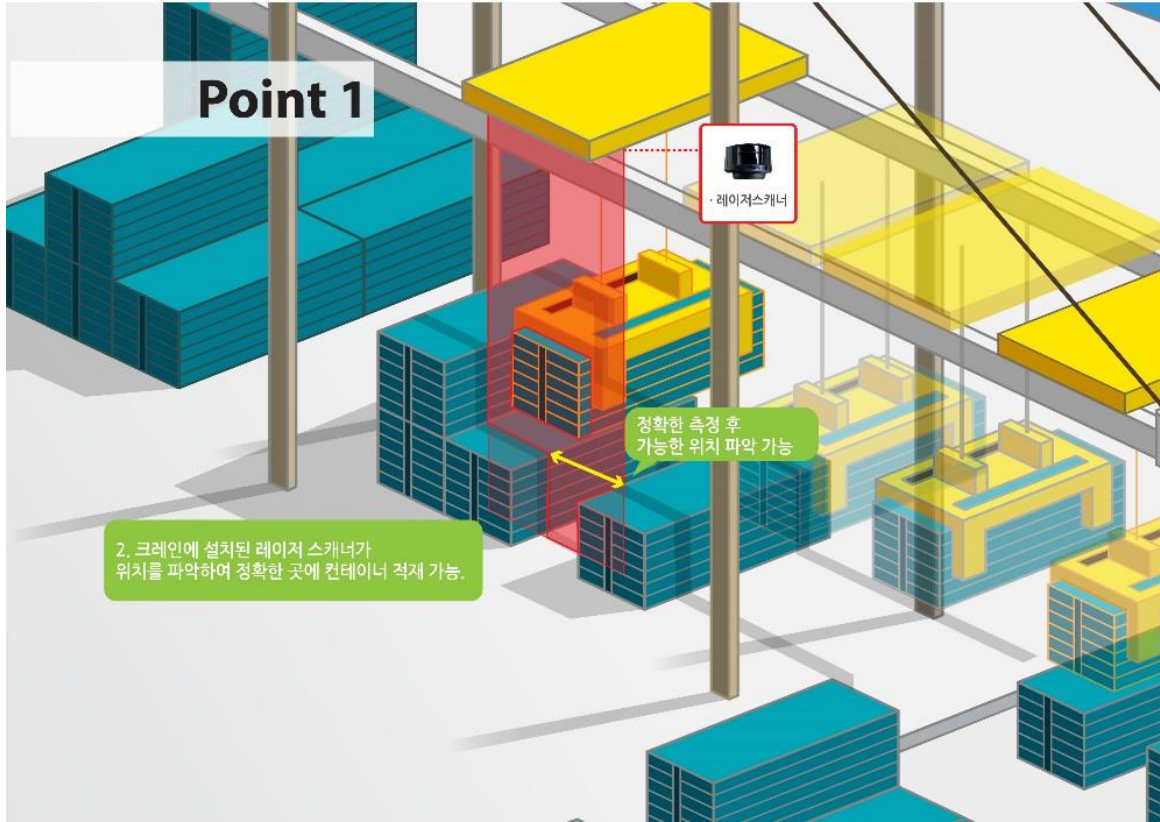

SMART
INDUSTRY

스마트 인터스트리

공장 내 안전사고 예방

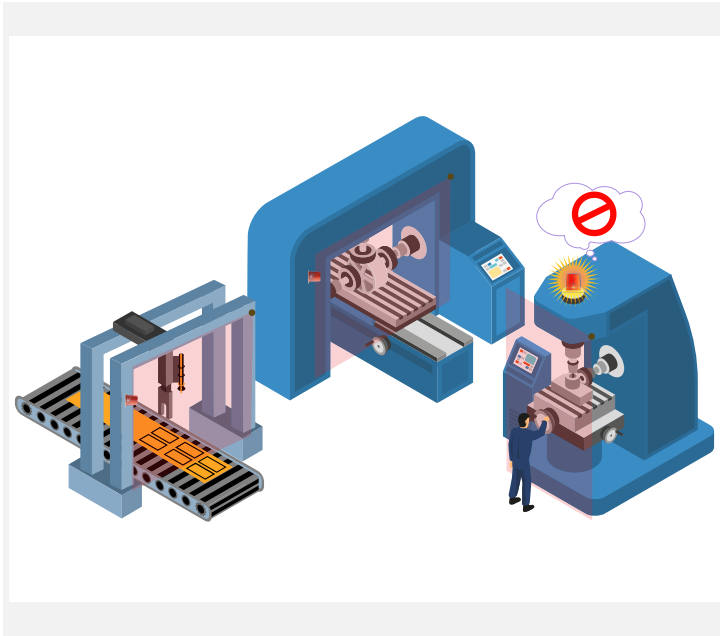

안전 위험 알림

산업 기계들과 접촉하여, 사람이 감지되면 경광등과 연동하여 위험 알림을 줄 수 있습니다.

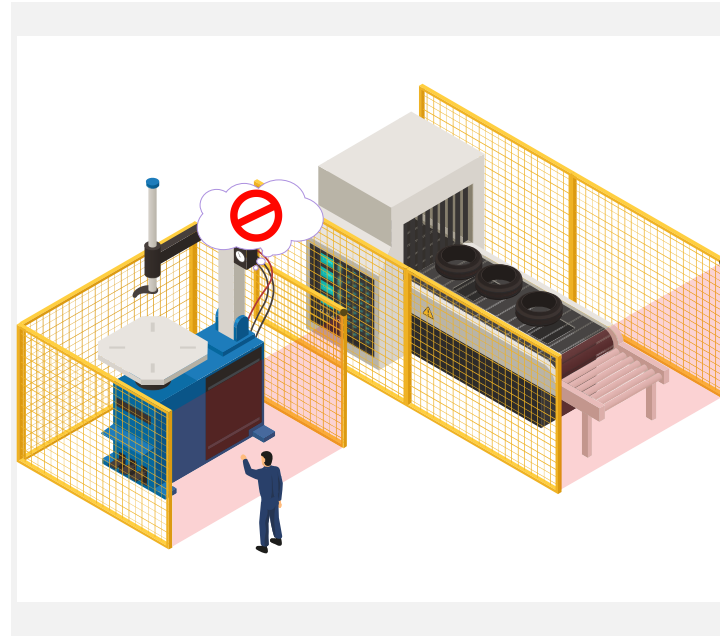

라이트 커튼 대체

선으로 감지되는 라이트커튼에 비해 레이저 스캐너는 면 감지형 센서로, 보다 정밀하고 넓은 감지영역을 가집니다.

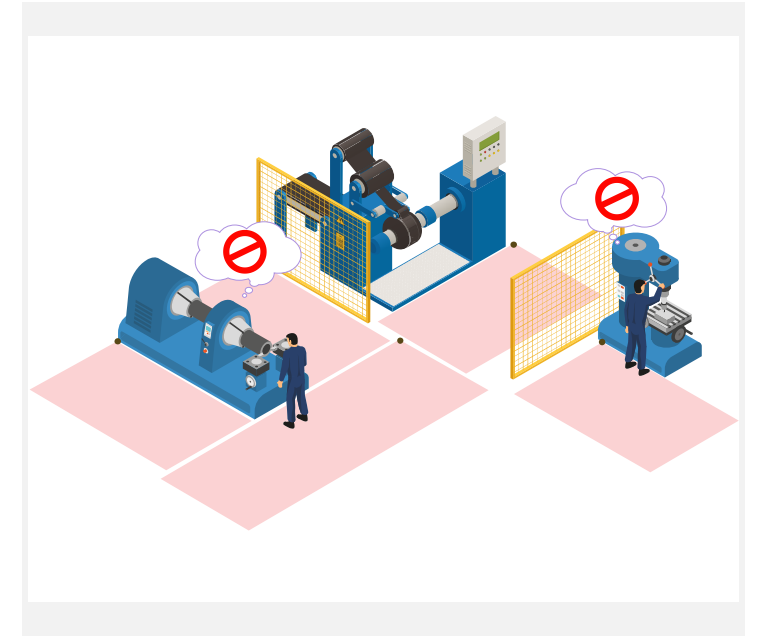

안전 매트 대체

안전매트를 대용할 수 있습니다. 레이저스캐너는 안전매트에 비해 효율적이고 비용이 저렴하며, 다양한 부가 기능을 갖추고 있습니다.

SMART
INDUSTRY

스마트 인더스트리
공장 내 안전사고 예방

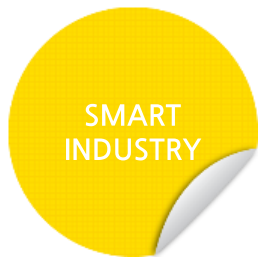
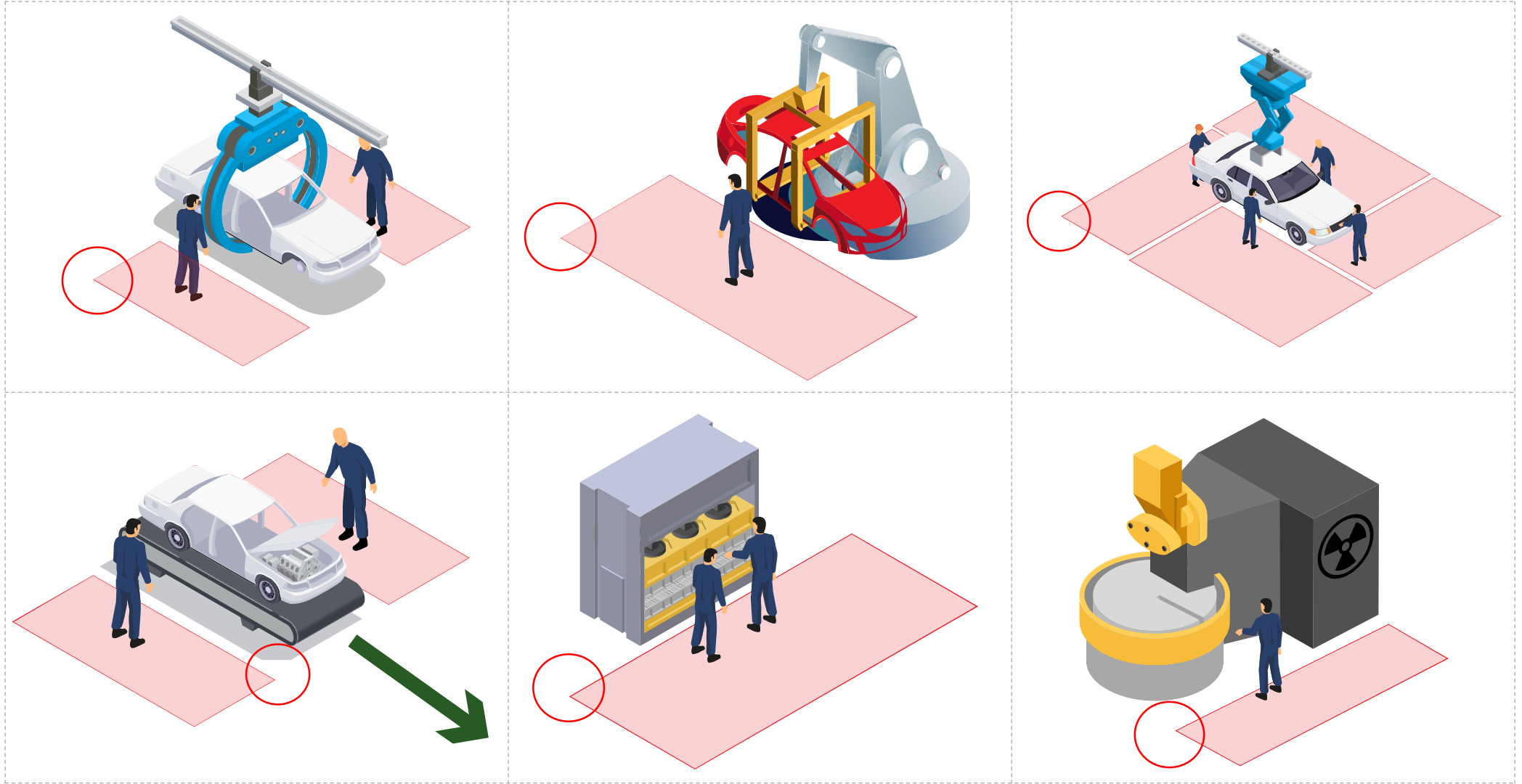

스마트 인터스트리

IoT 솔루션



SMART INDUSTRY

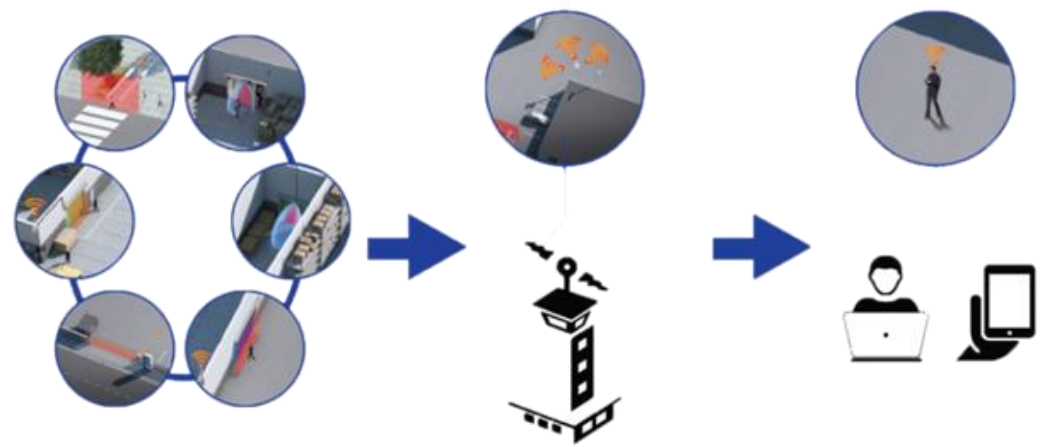

- 지능형 인식 및 자동 제어
- 외부 정보 수집, 전달

- 정보 연동
- 자료 수집, DB 구축

- 관리자 정보 전달
- 알림, 지시
- 원격 제어

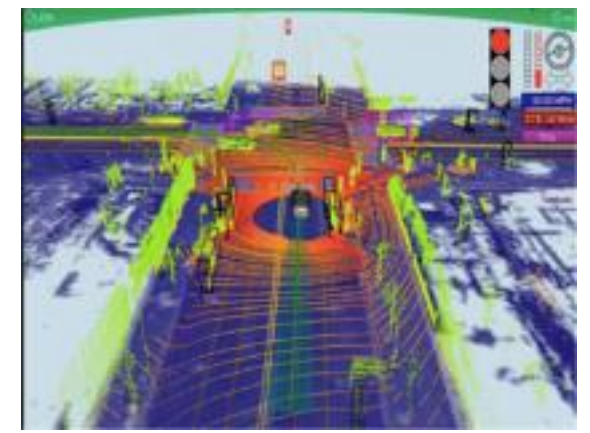
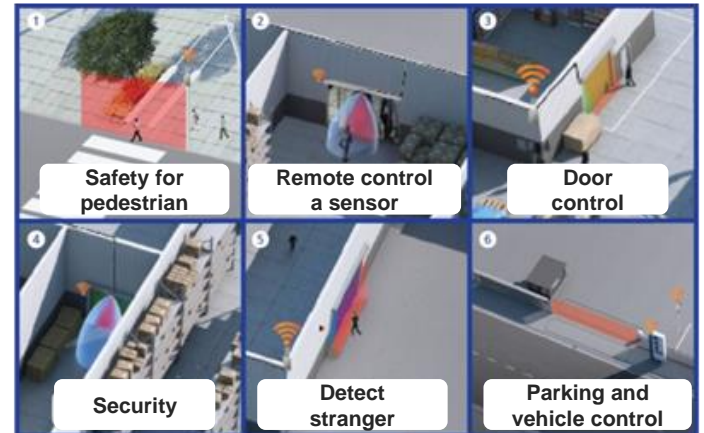

스마트 인터스트리

수위, 변화량 측정

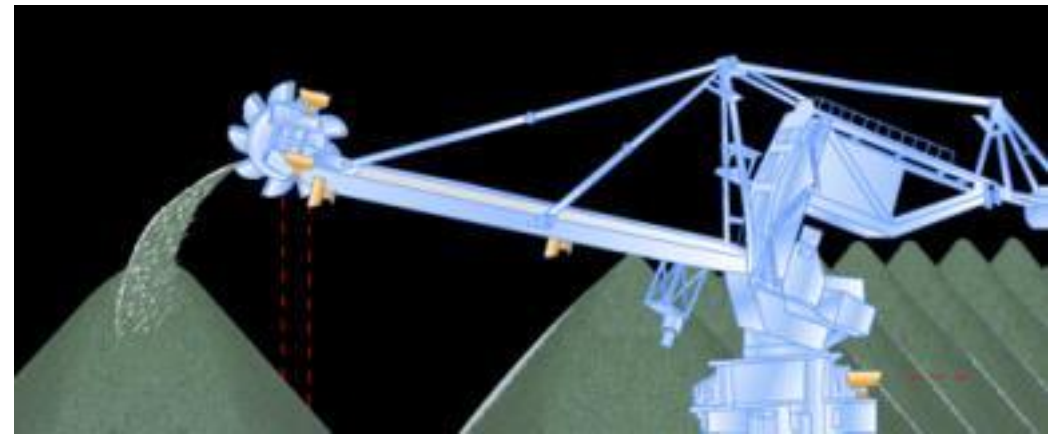
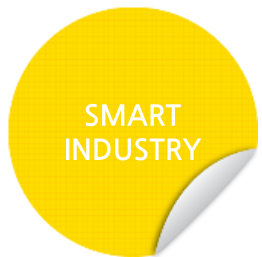
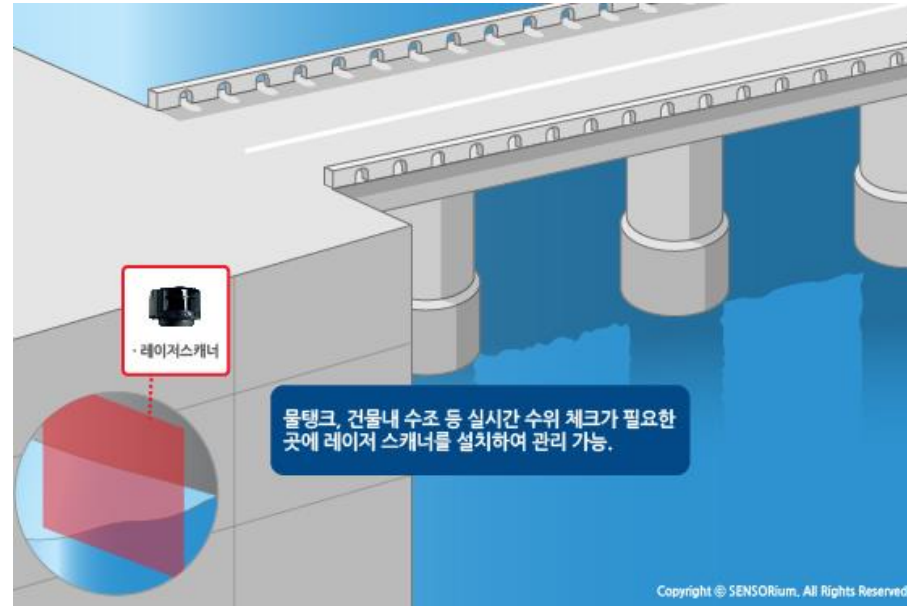
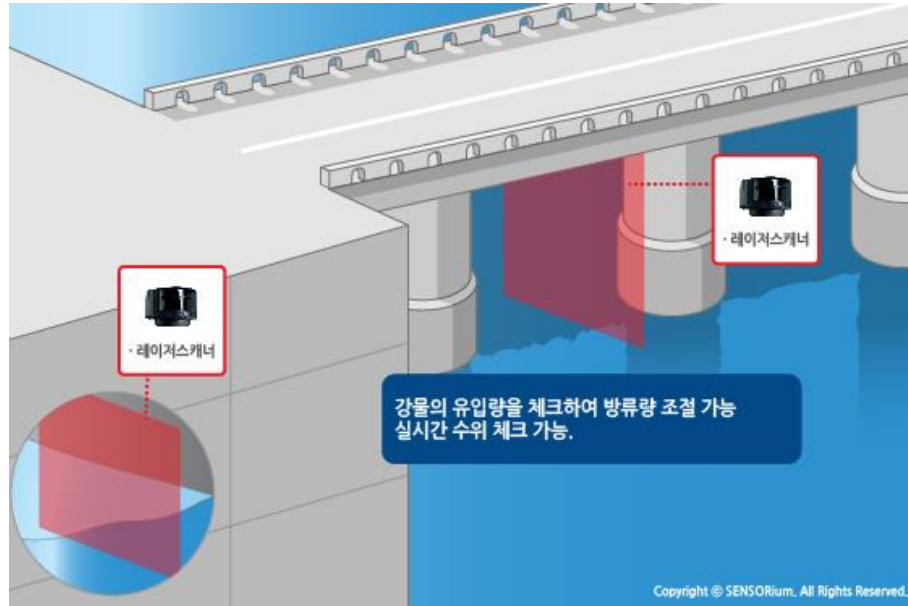

스마트 인더스트리
적재량 측정

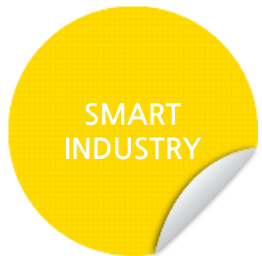
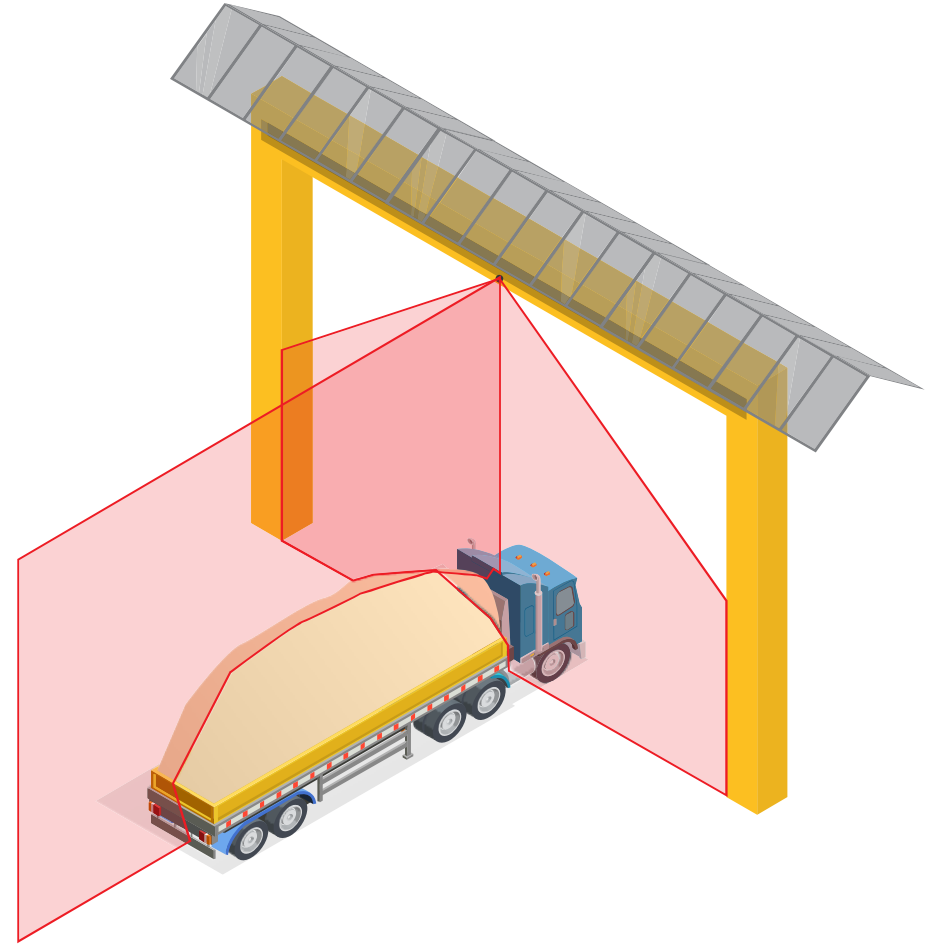
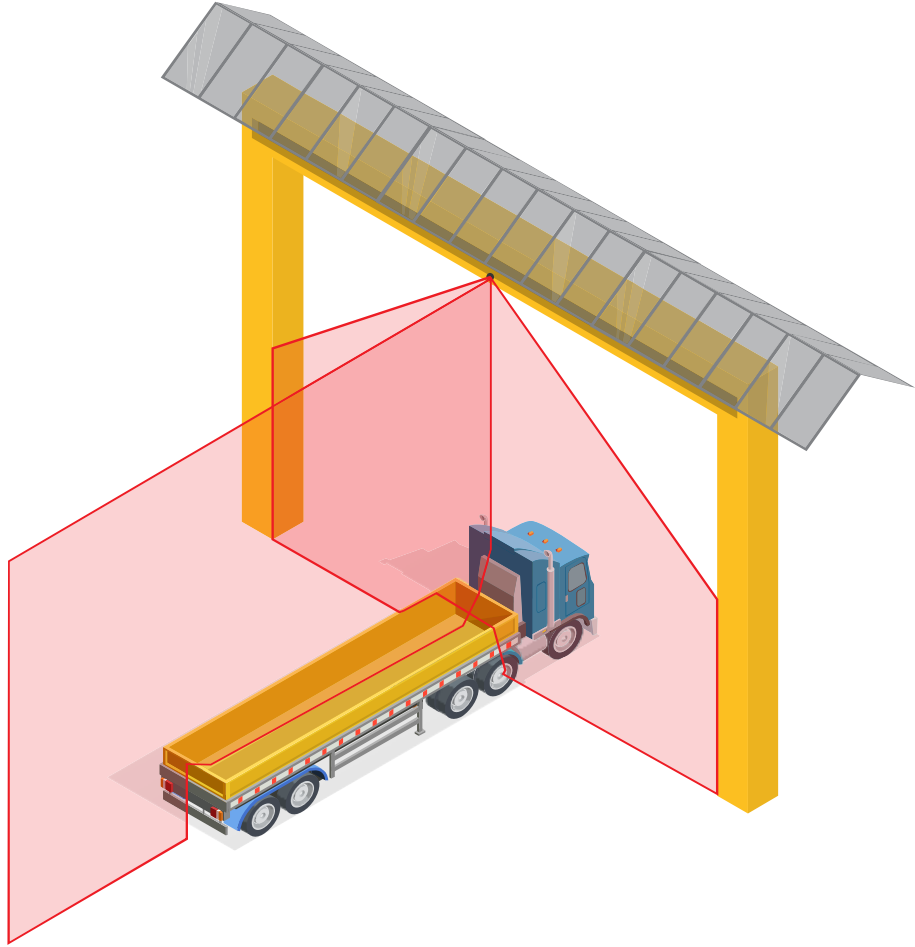

스마트 인터스트리

공장 진입시 높이 감지, 진입 제한

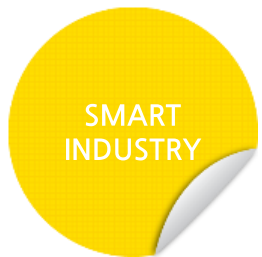
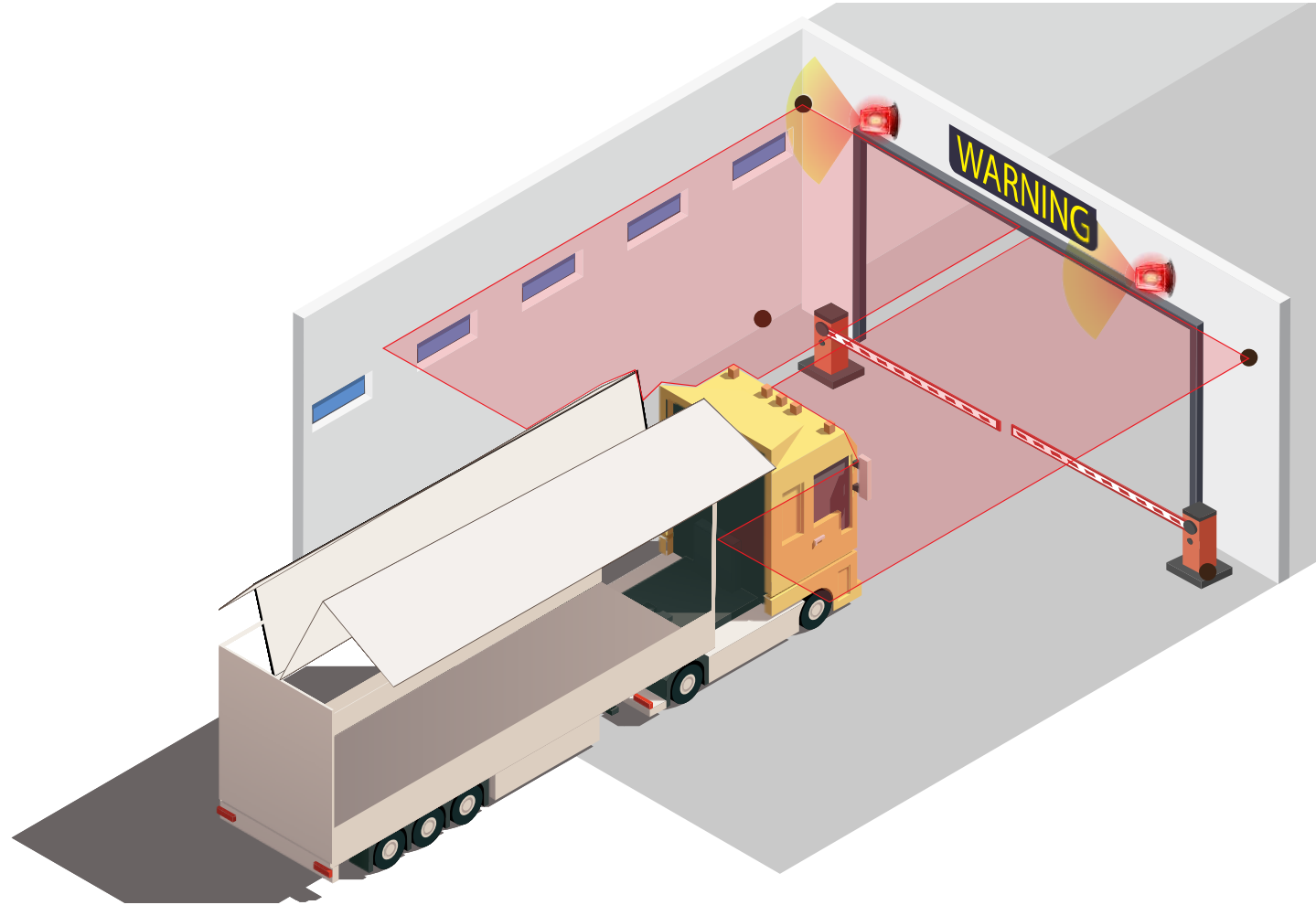

스마트 인터스트리
지게차 감지 솔루션

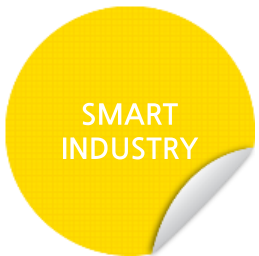
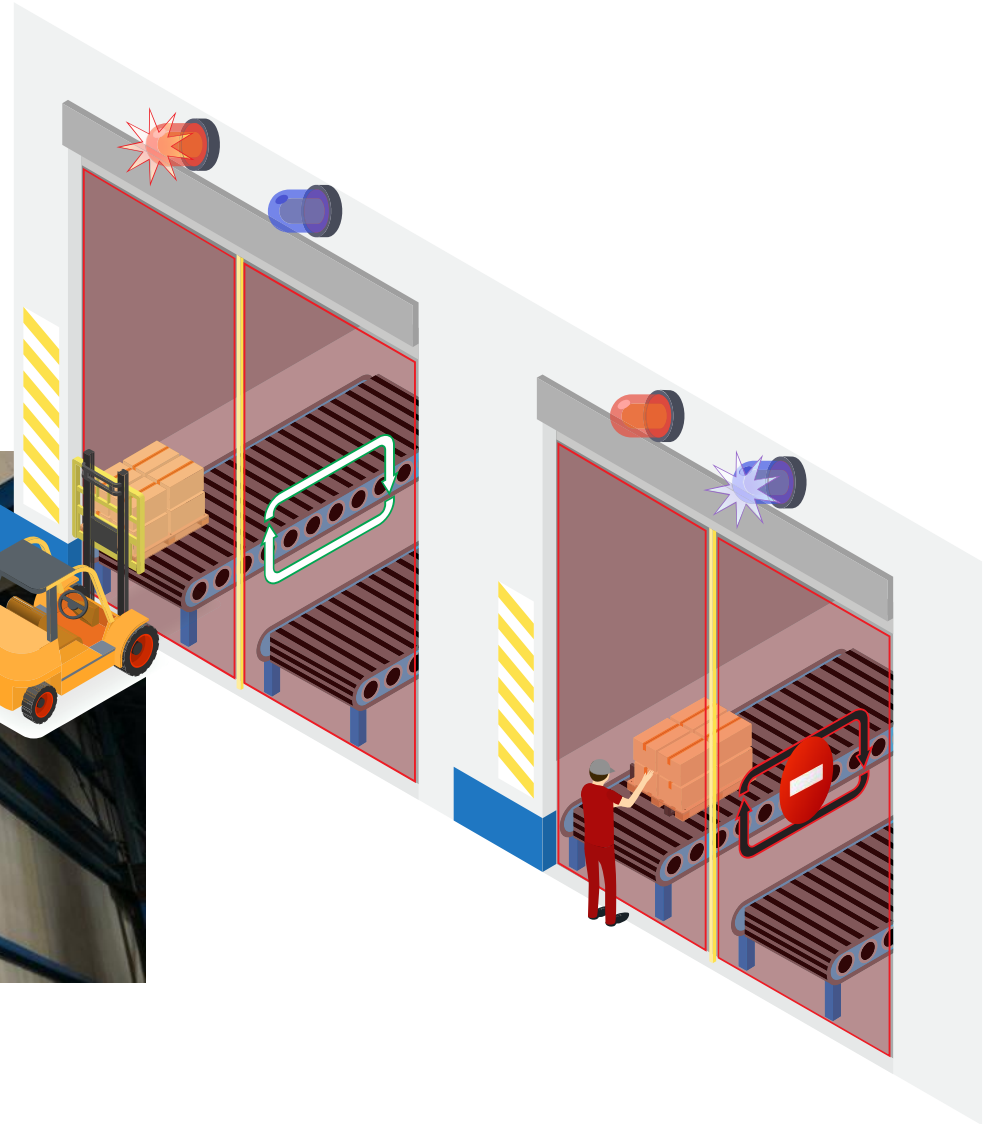

스마트 인터스트리
지게차 카운팅

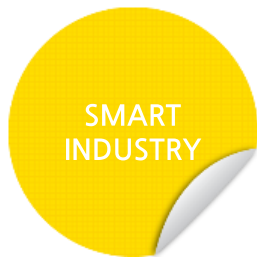
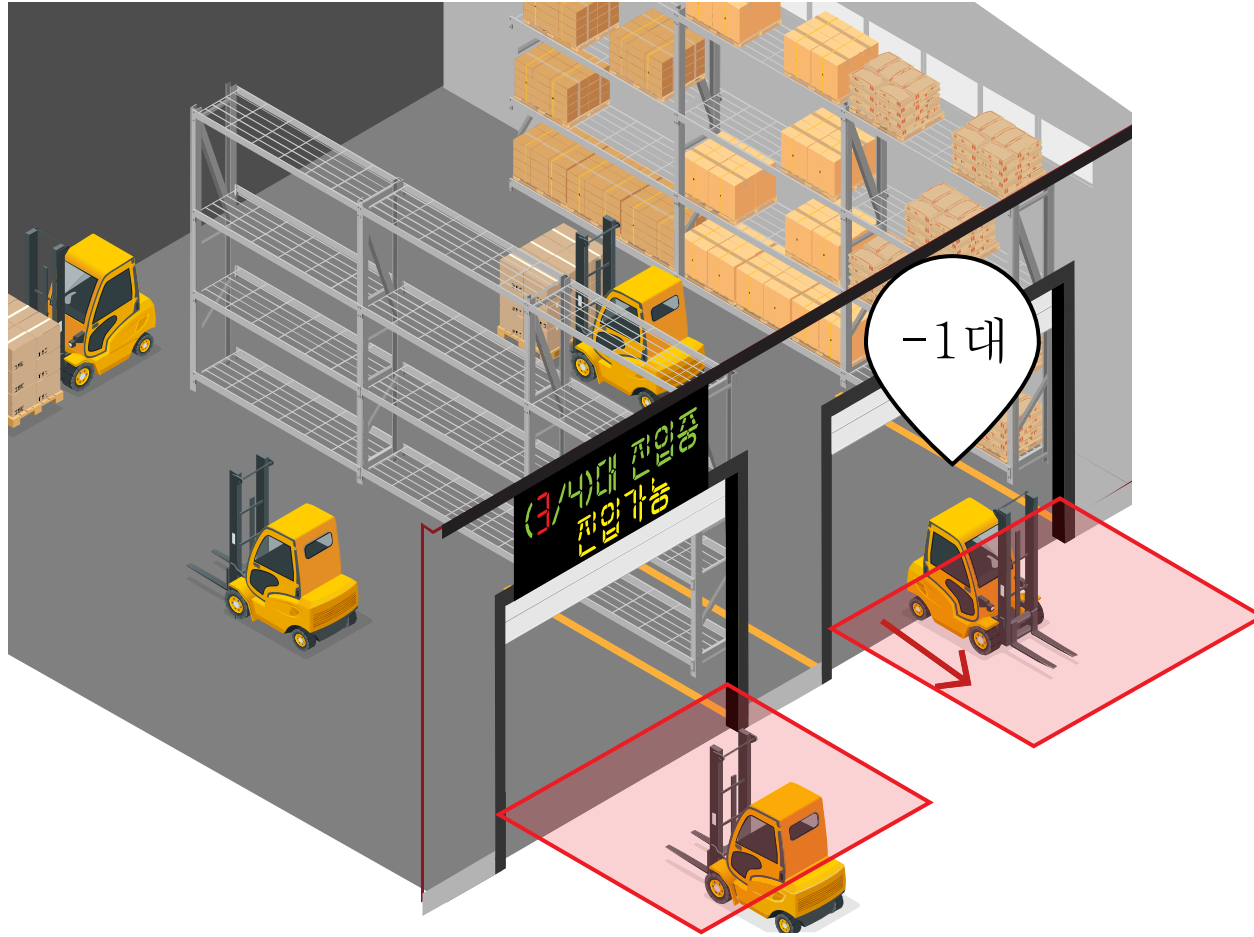

스마트 인터스트리

공장 내 횡단보도 안전 알림



SMART
INDUSTRY

스마트 인터스트리

차량 제작 테스트 공정 내 카운팅(QC Line)

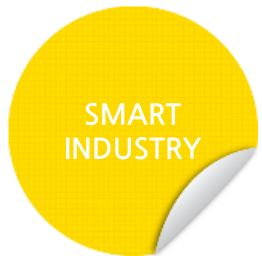
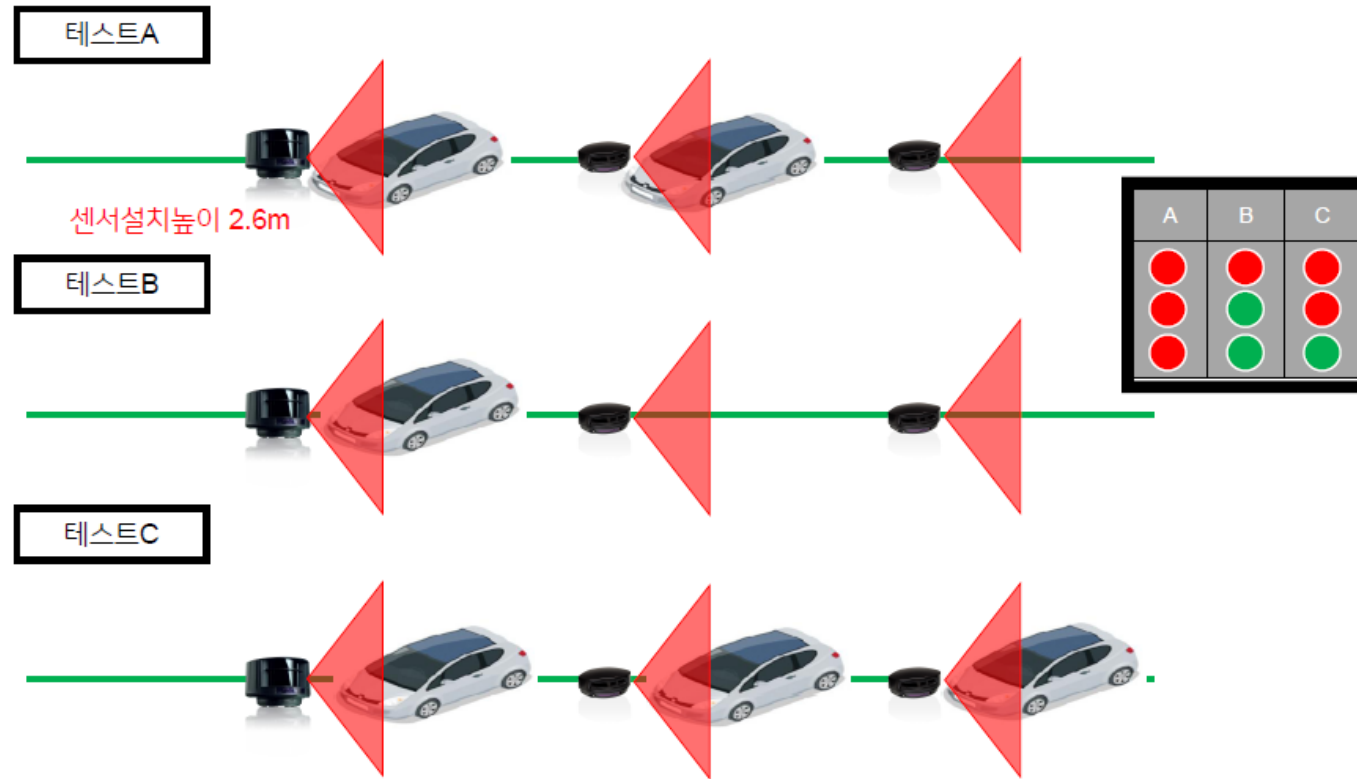

스마트 인터스트리

프로파일링

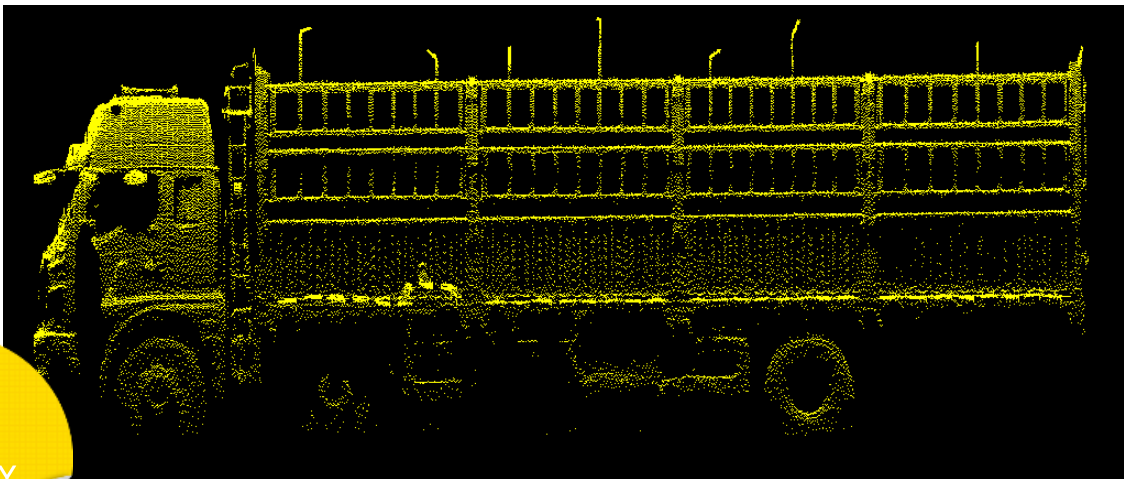

SMART
INDUSTRY



스마트 인터스트리

높이 제한

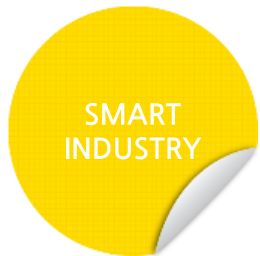

스마트 인터스트리
누액 감지 센서 대체

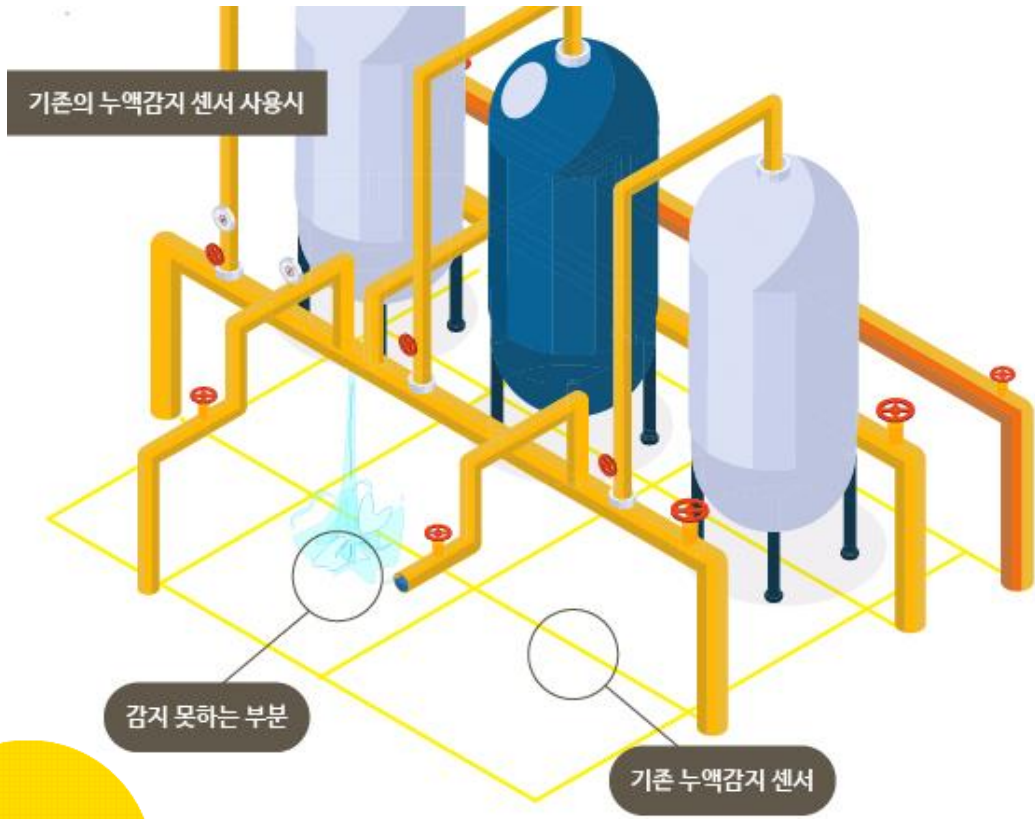

스마트시티
보행자 안전 감지

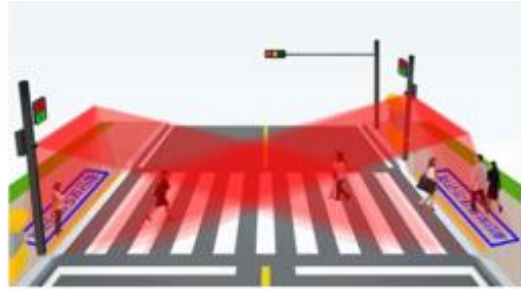

스마트시티

횡단보도 음성 안내 시스템

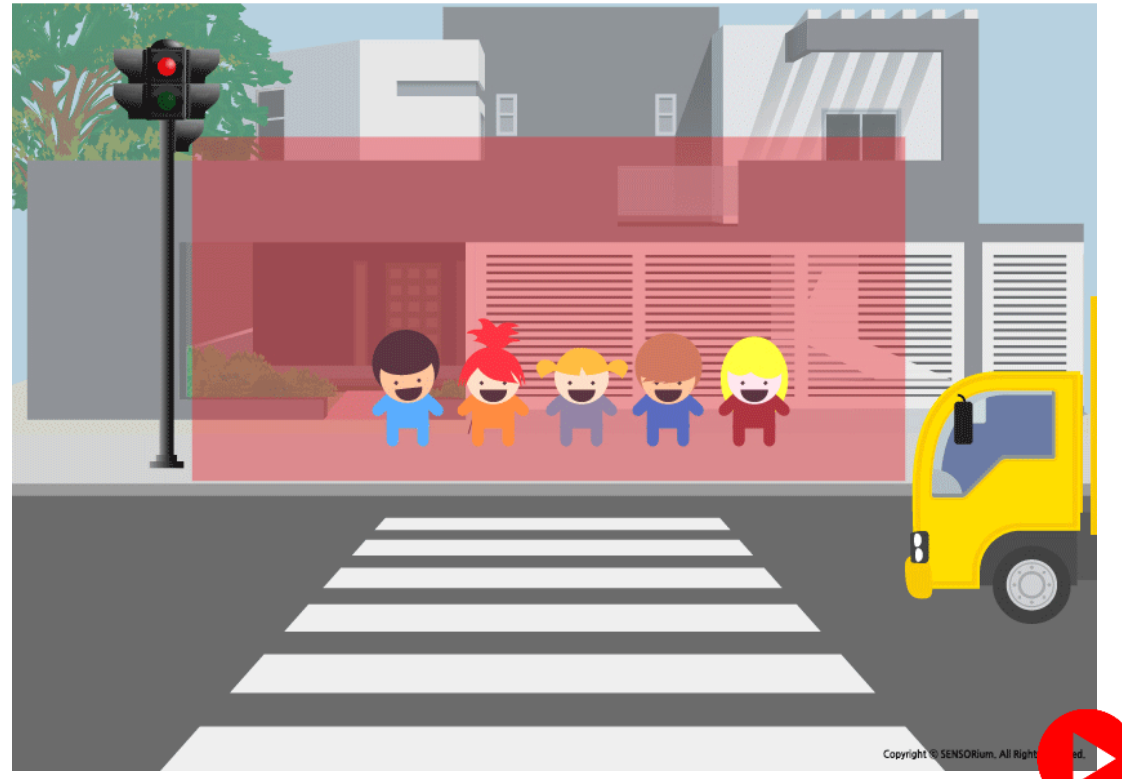

스마트시티

횡단보도 음성 안내 시스템

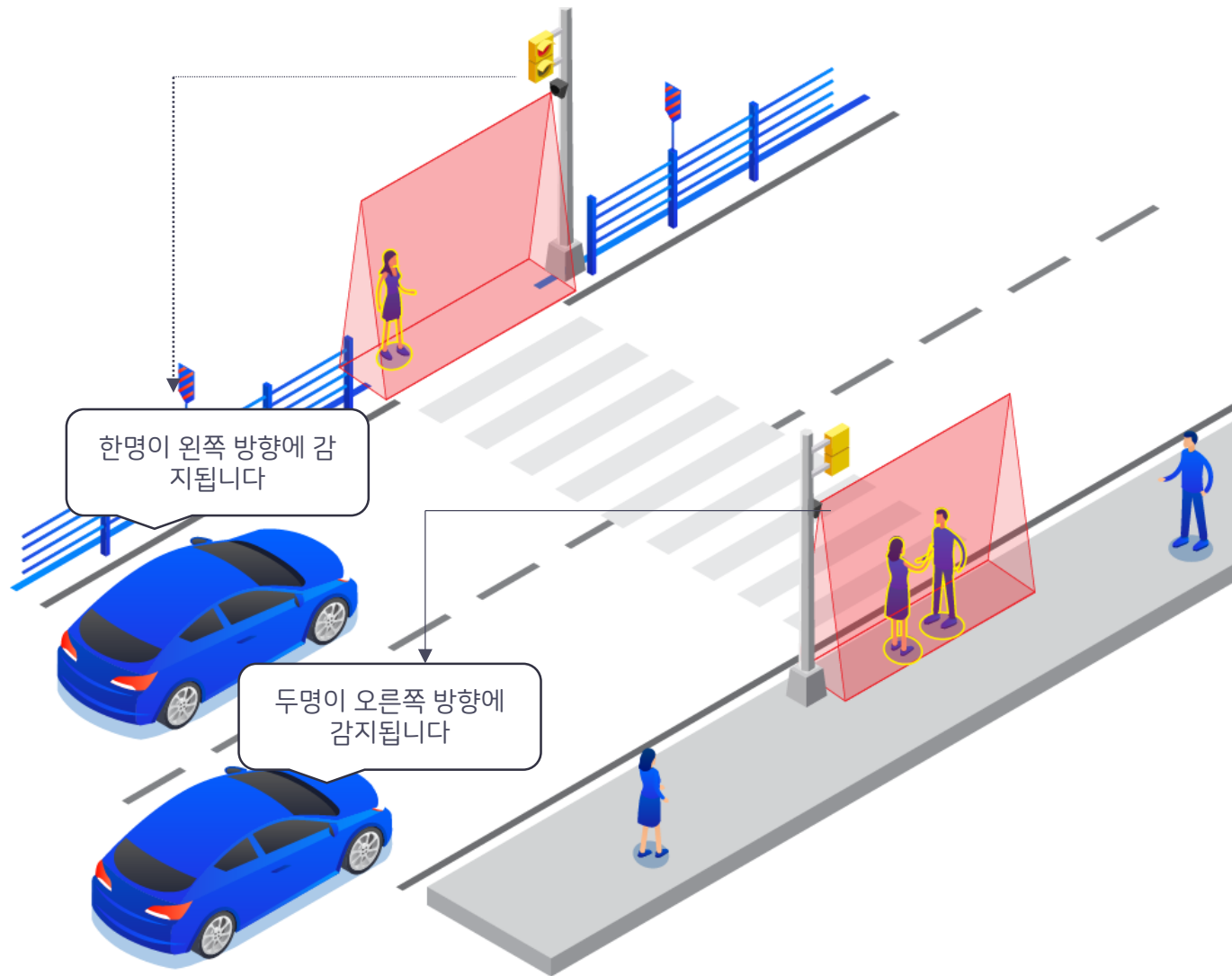

스마트시티

교량 위 사람 감지, 알림 시스템

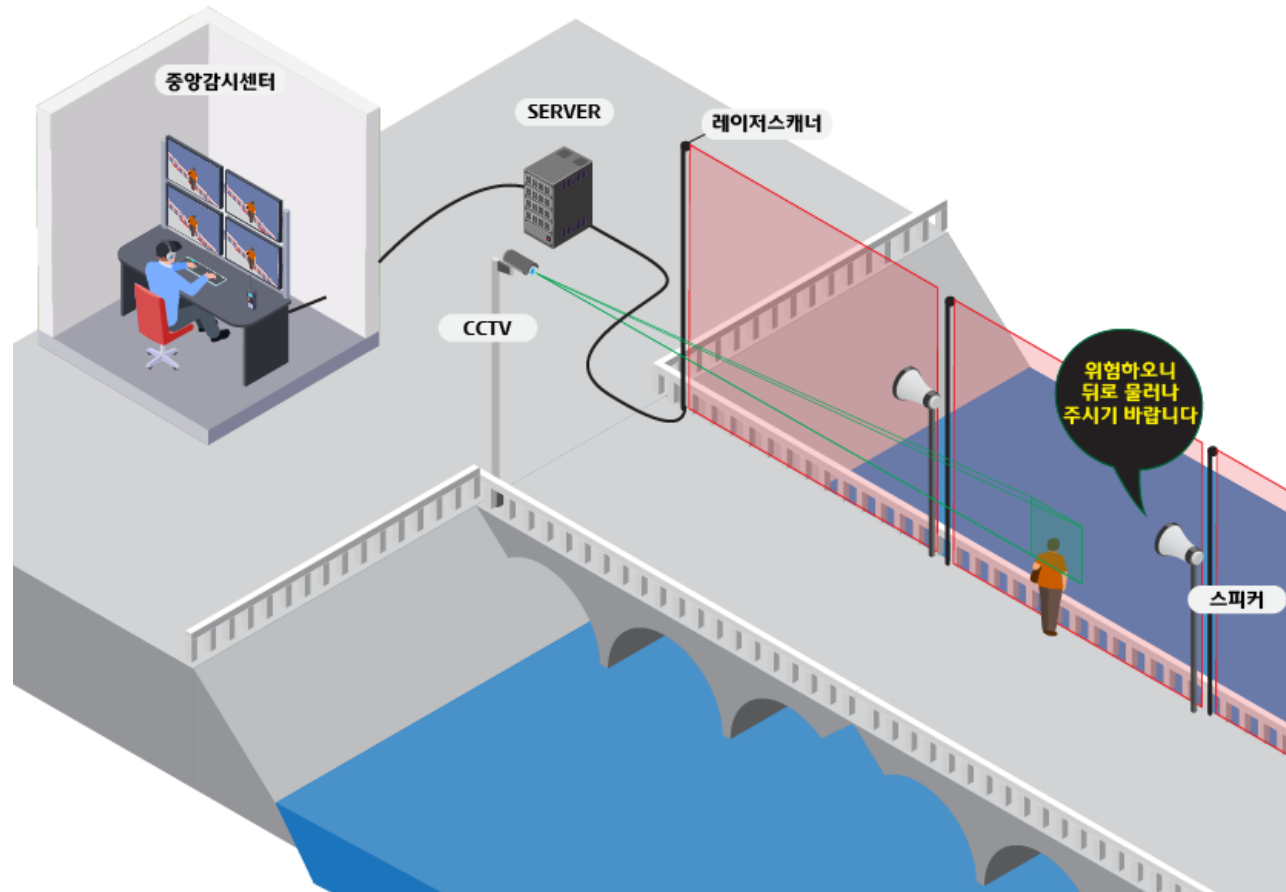

미디어아트
인터랙티브 아트 스포츠



미디어아트

인터랙티브 아트 게임



1 요즘 늘어나고 있는 인터랙티브 미디어입니다
레이저 1면인 플랫폼을 사용하였습니다



2 플랫폼 1대로 전체 영역을 커버합니다.
레이저 영역을 터치하면 미디어 월이 반응합니다.



3 센서리움의 레이저스캐너, 플랫폼은 이처럼 다양한
시장에서 사용할 수 있습니다.



4 레이저 영역을 손으로 터치하면, 위와 같이
미디어 월이 반응합니다.

MEDIA
ART

기타 솔루션

매직슬라이더 (가정용 자동문)



MAGIC SLIDER는 베란다, 중문 등 수동 미닫이 문에 부착하여 수동문을 자동으로 만들어 주는 제품입니다. 온 가족과 애완동물은 물론, 몸이 불편하신 분들도 사용할 수 있습니다.

R&D



자체 개발 솔루션

개발보드

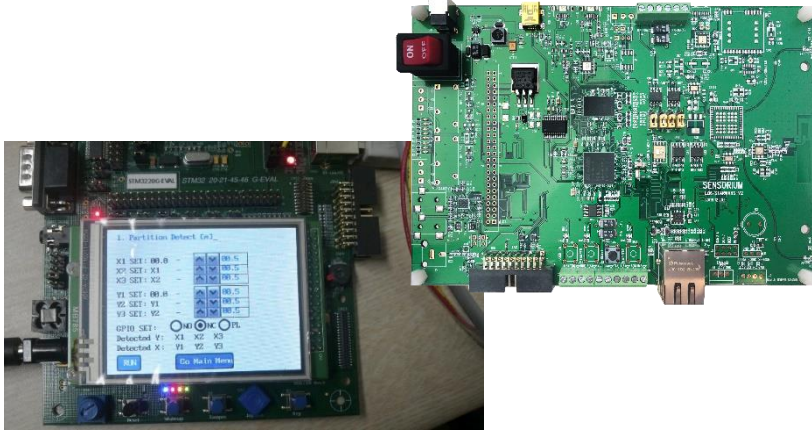

경차판별

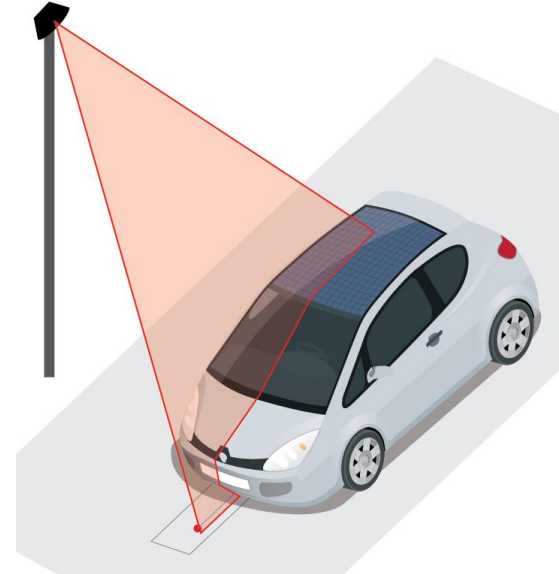



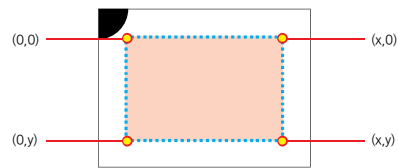



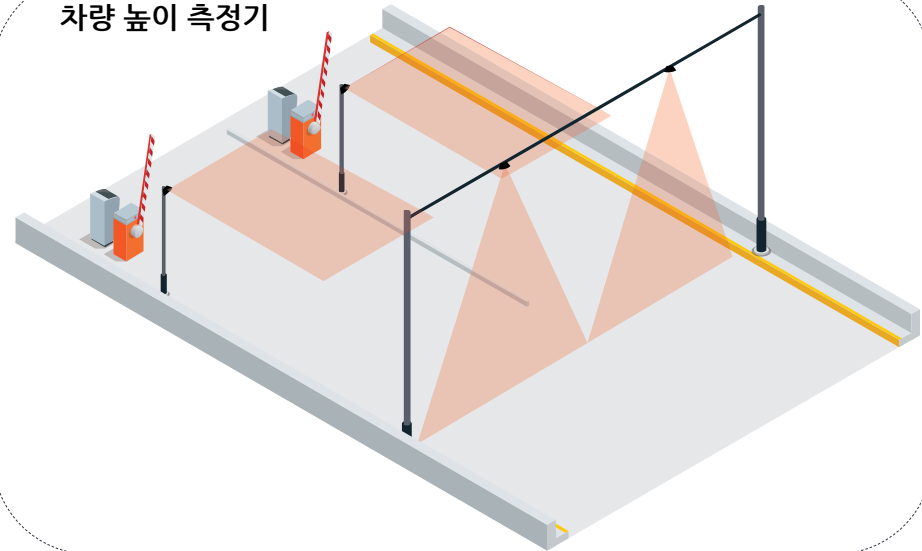













인터랙티브 아트

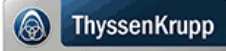

차량 높이 측정기



주요 고객현황

 <p>Incheon Airport</p> <p>인천공항</p>	 <p>KUMHO TYRES</p> <p>금호타이어</p>	 <p>HYUNDAI MOBIS</p> <p>현대모비스</p>	 <p>HYUNDAI</p> <p>현대자동차</p>	 <p>MITSUBISHI</p> <p>미쓰비시</p>
 <p>Seoul Metro</p> <p>서울 메트로</p>	 <p>KORAIL</p> <p>코레일</p>	 <p>DTRON</p> <p>대구도시철도공사</p>	 <p>POSCO E&C</p> <p>포스코 E&C</p>	 <p>SHINSEGAE</p> <p>신세계</p>
 <p>KIA</p> <p>기아자동차</p>	 <p>HYUNDAI ELEVATOR CO., LTD.</p> <p>현대엘리베이터</p>	 <p>POSCO</p> <p>포스코</p>	 <p>ThyssenKrupp</p> <p>티센크루</p>	 <p>Home plus</p> <p>홈플러스</p>
 <p>ADT</p> <p>ADT캡스</p>	 <p>LOTTE WORLD</p> <p>롯데월드</p>	 <p>대한민국 1등 할인점 emart</p> <p>이마트</p>	 <p>USFK</p> <p>USFK</p>	 <p>OTIS</p> <p>오티스 엘리베이터</p>
 <p>LOTTE CORPORATION</p> <p>롯데물산</p>				

THANK YOU

(주)센서리움

경기도 하남시 조정대로 150 아이테크 오렌지존 651호
TEL : 031-795-5077 FAX : 031-790-1034